

DDV9355

USER'S GUIDE



SSC-DDV9355

With

- Multi-Brand Remote Control
- 4-Head VCR x 4-Head VCR

DDV9355

User's Guide

Go-Video, Inc.

A Division of Sensory Science Corp.

7835 East McClain Drive
Scottsdale, Arizona USA 85260

www.govideo.com

www.sensoryscience.com

WARNING:

To reduce the risk of fire or electric shock, do not expose this appliance to rain or moisture. Do not open the cabinet; dangerous high voltage is present. Refer servicing to qualified personnel only. This video cassette recorder should only be used with 120V, 60Hz (standard U.S. household) current.

Federal law provides severe civil and criminal penalties for the unauthorized reproduction, distribution, or exhibition of copyrighted motion pictures and videotapes. (Title 17, United States Code, Sections 501 and 506).

USER/INSTALLER CAUTION:

Your authority to operate this FCC certified equipment could be voided if you make changes or modifications not expressly approved by the manufacturer, who is responsible for compliance with Part 15 FCC rules.

NOTE TO CATV SYSTEM INSTALLER:

This reminder is provided to call the CATV system installer's attention to Article 820-40 of the National Electronic Code that provides guidelines for proper grounding and, in particular, specifies that the cable ground shall be connected to the grounding system of the building, as close to the point of cable entry as practical.

CAUTION:

To prevent fire, shock hazard, or annoying interference, use only the recommended accessories.

To prevent electric shock, do not use this (polarized) plug with an extension cord, receptacle, or other outlet unless the blades can be fully inserted to prevent blade exposure.

To reduce the risk of electric shock, do not remove the unit cover or back. There are no serviceable parts inside. Refer servicing to qualified personnel only.

CUIDADO:

Para prevenir incendio, riesgo de choque, o interferencia enfadosa, use solamente los accesorios recomendados.

Para prevenir electrochoque, no use este enchufe (polarizado) con un cordón de extensión, toma de corriente, o cualquier otra toma a menos que los dientes puedan ser completamente insertados para prevenir exposición de los dientes.

Para reducir el riesgo de descarga eléctrica, no remueva la cubierta o la parte posterior del VCR. Dentro del VCR no hay partes que requieren servicio. Diríjase solamente a personal calificado cuando requiera servicio.

ATTENTION:

Pour éviter les incendis, risque de chocs, ou interférences fâcheuses, employer seulement les accessoires recommandés.

Pour éviter les chocs électriques, ne pas employer cette prise (polarisée) avec une rallonge, une prise de courant ou une autre sortie de courant à moins que les lames peuvent être insérées à fond pour l'exposition des lames.

Pour réduire les risques de chocs électriques, ne pas retirer le couvercle ou l'arrière du module. Il n'y a pas de pièce utilisable à l'intérieur. Ne faire effectuer l'entretien que par un personnel qualifié.



		This symbol is intended to alert the user to the presence of uninsulated dangerous voltage within the product's enclosure that may be of sufficient magnitude to constitute risk of fire or electric shock.
		This symbol is intended to alert the user to the presence of important operating and maintenance instructions in the literature accompanying this product.

Table of Contents

Safety v

Important Safety Instructions	v
-------------------------------------	---

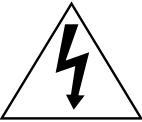
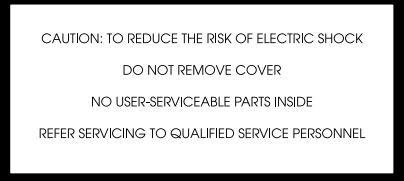
1 - Basic Connections 1

First Things First	1
Connect Antenna/Basic Cable	2

2 - Initial Settings 5

Auto Setup	5
Set Language Manually	6
Set Clock Manually	7
Set Daylight Savings Time	9
Set Time Zone	10
Set Auto Clock Set Channel	11

3 - The Dual-Deck System 13

Remote Control Overview	13
Front Panel Overview	15
Front Panel Auxiliary Input	16
Front Panel Display	17
Front Panel Display Settings	18
Child Lock	19
Remote Eject	20
Main Menu Tree	21
Setup Menu Tree	22
Menu Navigation - Remote Control	23
Menu Navigation - Front Panel	24
Reset Factory Settings	25
On-Screen Display Overview	26
On-Screen Display Elements	27
On-Screen Display (OSD) Settings	28

Go-Video is a registered trademark of Sensory Science Corporation. Copy Tape, Video Sequencing, and Dual-Deck VCR are trademarks of Sensory Science Corporation. All other brand and product names are trademarks or registered trademarks of their respective companies.

4 - Tuner & Channel List 29

Tuner Band	29
Auto Channel Search	30
Add Channel	31
Remove Channel	32
Show Weak Channels	33

5 - Copy Features 35

Basic Copying	35
EZ Copy	36
Copy Mode	37
Speed Matching	38
Copy Audio Insert	39

6 - Playback Features 41

Basic Playback	41
Special Playback Features	42
Tracking	43
Sequential/Loop Playback	44
Auto Play/Rewind	45

7 - Recording Features 47

Basic Recording	47
Recording Options	48
One-Touch Recording (OTR)	49
Record Speed	50
Record Source	51
Sequential/Loop Recording	52
Date/Time Stamp	53

8 - Timer Recording 55

How to Set a Timer Recording	55
Timer Recording Errors	60

9 - Editing Features 61

8-Scene Editor	61
Sync Editing	64
How to Cut Commercials with Skip Edit	66
On-Screen Titler	67
Recording Titler Message	68

10 - Search/Index Features 69

Overview	69
Placing Index Marks	70
Index Scan	71
Index Search	72
Blank Search	73
Direct Time Search	74
Return to 0:00:00	75

11 - Advanced Connections 77

Cable Box Hookup	77
Audio Connections	79
TV Monitor Connections	80
Connecting Other Video Equipment	81

Appendix A - Multi-Brand Remote Setup 83

Multi-Brand Remote Setup	83
Multi-Brand Remote Operation	84

Appendix B - Help 85

Frequently Asked Questions (FAQs)	85
Technical Specifications	90
Dual-Deck VCR Limited Warranty	91

Index 93

Important Safety Instructions



PORTABLE CART WARNING

(Symbol provided by RETAC)

1. **READ INSTRUCTIONS** - All the safety and operating instructions should be read before the unit is operated.
2. **RETAIN INSTRUCTIONS** - The safety and operating instructions should be retained for future reference.
3. **HEED WARNINGS** - All warnings on the unit and in the operating instructions should be adhered to.
4. **FOLLOW INSTRUCTIONS** - All operating and maintenance instructions should be followed.
5. **CLEANING** - Unplug this video unit from the wall outlet before cleaning. Do not use liquid or aerosol cleaners. Use a dry cloth for dusting cabinet.
6. **ATTACHMENTS** - Do not use attachments not recommended by the video product manufacturer, as they may be hazardous.
7. **WATER & MOISTURE** - Do not use this video unit near water—for example, near a bathtub, wash bowl, kitchen sink, laundry tub, in a wet basement, near a swimming pool or the like.
8. **ACCESSORIES** - Do not place this video unit on an unstable cart, stand, tripod, bracket or table. The video unit may fall, causing serious injury to a child or adult, and serious damage to the unit. Use only with a cart, stand, tripod, bracket or table recommended by the manufacturer or sold with the video unit. Any mounting of the unit should follow the manufacturer's instructions and should use a mounting accessory recommended by the manufacturer.
- 8a. An appliance and cart combination should be moved with care. Quick stops, excessive force, and uneven surfaces may cause the appliance and cart combination to overturn.
9. **VENTILATION** - Slots and openings in the cabinet are provided for ventilation to ensure reliable operation of the video unit and to protect it from overheating. These openings must not be blocked or covered. Never place your VCR on a bed, sofa, rug or other similar surface, on or near a radiator or heat register. This video unit should not be placed in a built-in installation such as a bookcase or rack unless proper ventilation is provided or the manufacturer's instructions have been adhered to.
10. **POWER SOURCES** - This video unit should be operated only from the type of power source indicated on the marking label. If you are not sure of the type of power supply to your home consult your appliance dealer or local power company. For video units intended to be operated from battery power, or other sources, refer to the operating instructions.
11. **GROUNDING OR POLARIZATION** - This video unit may be equipped with either a polarized 2-wire AC line plug (a plug having one blade wider than the other) or a 3-wire grounding plug having a third (grounding) pin.
The 2-wire polarized plug will fit into the power outlet only one way. This is a safety feature. If you are unable to insert the plug fully into the outlet try reversing the plug. If the plug still fails to fit, contact your electrician to replace your obsolete outlet. Do not defeat the safety purpose of the polarized plug.
12. **POWER-CORD PROTECTION** - Power-supply cords should be routed so that they are not likely to be walked on or pinched by items placed upon or against them, paying particular attention to cords of plugs, convenience receptacles, and the point where they exit from the unit.
13. **OUTDOOR ANTENNA GROUNDING** - If an outside antenna or cable system is connected to the video unit, be sure the antenna or cable system is grounded to provide some protection against voltage surges and built-up static charges. Section 810 of the National Electrical Code, ANSI/NFPA No. 70-1984, provides information with respect to proper grounding of the mast and supporting structure, grounding of the lead-in wire to an antenna discharge unit, size of grounding conductors, location of antenna-discharge unit, connection to grounding electrodes, and requirements for the grounding electrode. See figure below.

14. **LIGHTNING** - For added protection of this video unit during a lightning storm, or when it is left unattended and unused for long periods of time, unplug it from the wall outlet and disconnect the antenna or cable system. This will prevent damage to the video unit due to lightning and power line surges.
15. **POWER LINES** - An outside antenna system should not be located in the vicinity of overhead power lines or other electric light or power circuits, where it can fall into such power lines or circuits. When installing an outside antenna system extreme care should be taken to keep from touching such power lines or circuits as contact with them might be fatal.
16. **OVERLOADING** - Do not overload wall outlets and extension cords as this can result in the risk of fire or electric shock.
17. **OBJECTS AND LIQUIDS** - Never push objects of any kind into this video unit through openings as they may touch dangerous voltage points or short out parts that could result in a fire or electric shock. Never spill liquids of any kind onto the unit. Should spillage occur, unplug unit and have it checked by a technician before use.
18. **SERVICING** - Do not attempt to service this video unit yourself as opening or removing covers may expose you to a dangerous voltage or other hazards. Refer all servicing to qualified service personnel.
19. **DAMAGE REQUIRING SERVICE** - Unplug this video unit from the wall outlet and refer servicing to qualified service personnel under the following conditions:
 - a. When the power supply cord or plug is damaged.
 - b. If any liquid has been spilled onto or objects have fallen into the video unit.
 - c. If the video unit has been exposed to rain or water.
 - d. If the video unit does not operate normally by following the operating instructions. Adjust only those controls that are covered by the operating instructions. Improper adjustment of other controls may result in damage and will often require extensive work by a qualified technician to restore the video unit to its normal operation.
 - e. If the video unit has been dropped or the cabinet has been damaged.
 - f. When the video unit exhibits a distinct change in performance—this indicates a need for service.
20. **REPLACEMENT PARTS** - When replacement parts are required, be sure the service technician has used replacement parts specified by the manufacturer or those having the same characteristics as the original part. Unauthorized substitutions may result in fire, electric shock or other hazards.
21. **SAFETY CHECK** - Upon completion of any service or repairs to this video unit ask the service technician to perform safety checks to determine that the video unit is in safe operating order.
22. **HEAT** - This video unit should be situated away from heat sources such as radiators, stoves, or other products (including amplifiers) that produce heat.

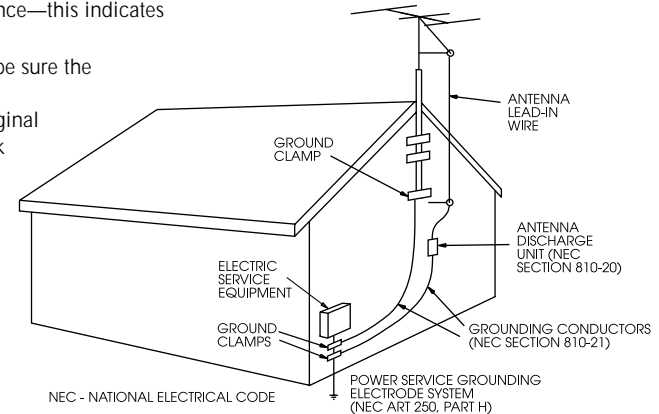

First Things First

1 Unpack your Dual-Deck VCR

As you unpack, please check that the following items are included in your Dual-Deck VCR packing case:

- Dual-Deck VCR
- User's Guide
- Remote Control
- 2 "AA" Batteries
- 1 RF (Radio Frequency) Antenna Cable
- Read Me First/Quick Reference Guide
- Warranty/Registration Card

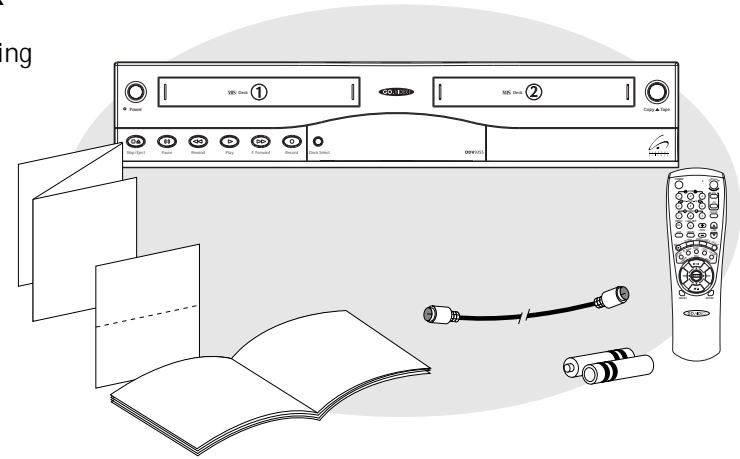

2 Insert Remote Control Batteries

Remove the battery cover by pushing down and sliding the cover in the direction of the arrow. Insert 2 "AA" batteries as shown, paying attention to the correct polarities (+/-). When finished, replace the cover.

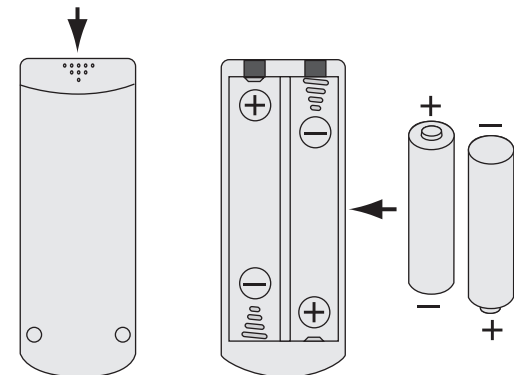

Connect Antenna/Basic Cable

Follow these steps only if you are using an indoor/outdoor antenna or basic cable. If you have a:

- Cable Box
- Stereo Receiver
- TV Monitor
- Third VCR
- Laserdisc Player
- DVD Player
- Camcorder
- Satellite Receiver
- Video Game

...or other advanced connection, please refer to Chapter 12.

1 Connect Antenna/Cable to VCR

Connect the RF antenna cable from your indoor/outdoor antenna or cable wall outlet to the IN (FROM ANT.) jack on the back panel of the VCR.

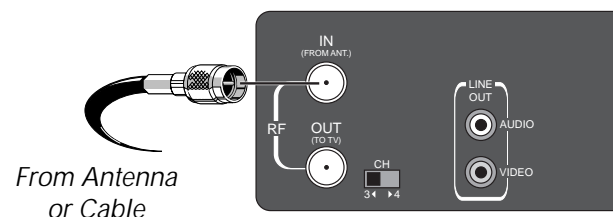

2 Connect VCR to TV

Connect the supplied RF cable from the OUT (TO TV) jack on the back panel of the VCR to your television's ANTENNA IN jack.

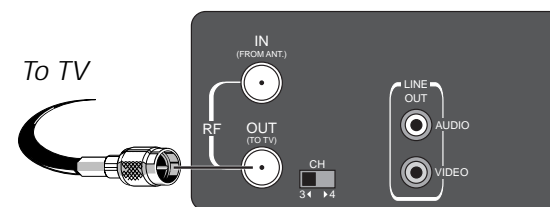

3 Set VCR Output Channel

Set the channel switch on the back panel of the VCR to 3 or 4, whichever is not an active channel in your area.

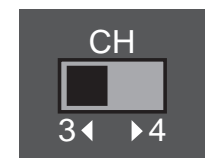

4 Plug In VCR

Connect the VCR power cord to a standard 120V/60Hz wall outlet.

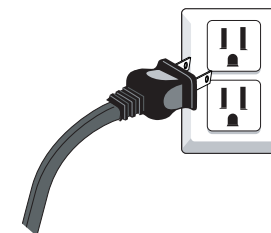

5 Turn On VCR

Press the Power button on the remote control or on the VCR's front panel.

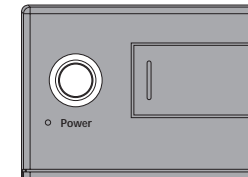
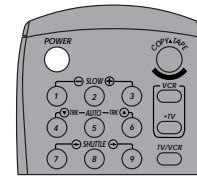

6 Turn On TV

Press the power button on your TV.

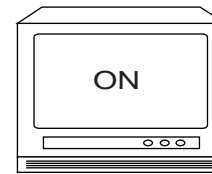

7 Tune TV to Channel 3 or 4

Be sure to select the same channel you used in Step 3.

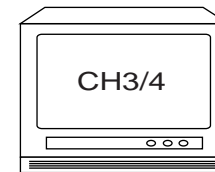

8 Basic Connection is Complete!

The Set Language menu will appear on your television screen. Please proceed with Auto Setup in Chapter 2.



2 - Initial Settings

Auto Setup

The first time you power on your Dual-Deck VCR, you will be prompted to select English, French, or Spanish for the on-screen menu system. Then the VCR will automatically search for channels and set the VCR's internal clock.

1 Set Language

Press 1, 2, or 3 to select English, French, or Spanish. To change the language at any other time, see page 6.

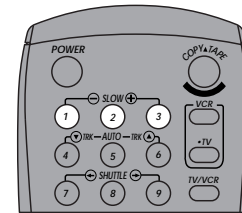

2 Run Auto Setup

As soon as you set the language, the VCR will automatically perform the following steps:

- **Auto Channel Search** — Automatically detects whether you have an antenna or cable, then searches for all active channels. If Auto Setup is unable to locate channels in your area, you can search and add channels manually; see page 30.
- **Auto Clock Set** — Sets the VCR's internal clock. If Auto Setup is unable to find a clock set channel in your area, you can set the clock manually; see page 7.

This procedure may take a few minutes to complete. When finished, it will tune the VCR to the lowest channel found.

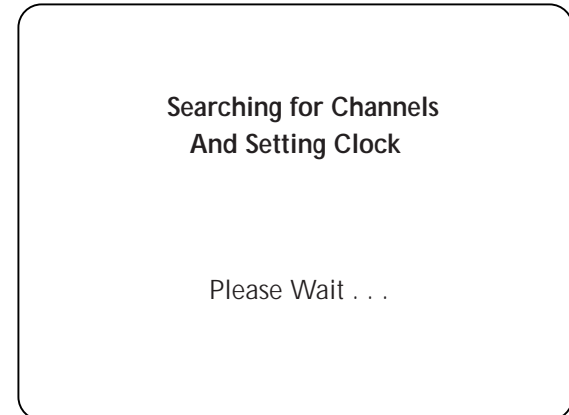

3 Auto Setup is Complete!

Proceed to Chapter 3 for an overview of the Dual-Deck System.

Set Language Manually

To change the on-screen language at any time, follow these steps.

1 Open "Main Menu"

Press the menu button on the remote control.

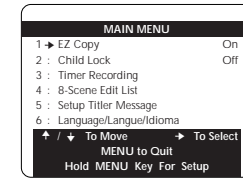
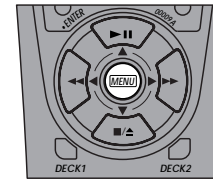

2 Select On-Screen Language

Press 6 to choose English, French, or Spanish. Each time you press the button, the entire Main Menu will be translated into English, French or Spanish.

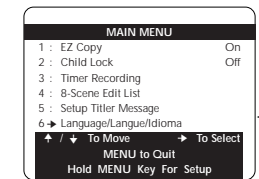
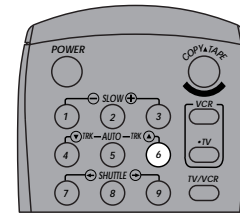

English

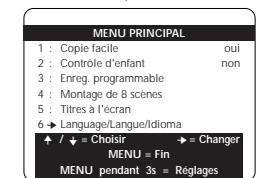

French

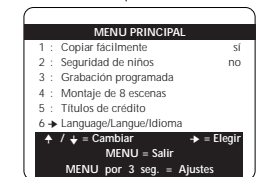

Spanish

Set Clock Manually

If Auto Clock Set is not available in your area, follow these steps to set the clock manually. If Auto Clock Set has set the time incorrectly, try adjusting Daylight Savings Time (page 9) and Time Zone (page 10) before setting the clock manually.

1 Open "Setup Menu"

Press and hold the Menu button for 3 seconds.

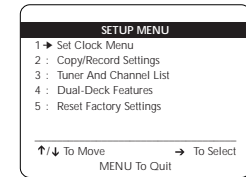
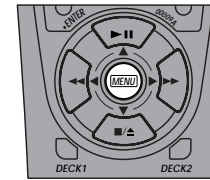

2 Select "Set Clock"

Press 1.

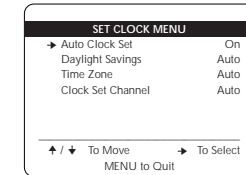
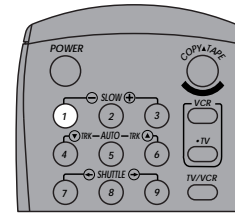

3 Turn Off "Auto Clock Set"

Press the right arrow key once.

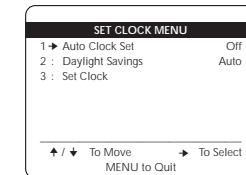
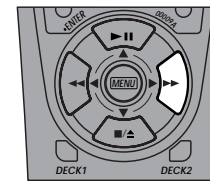

4 Choose "Set Clock"

Press the down arrow key until "Set Clock" is selected, then press the right arrow key to select.

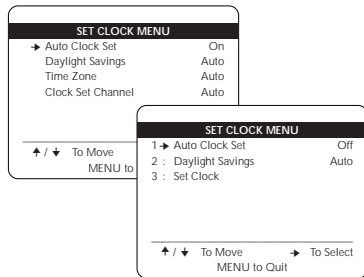
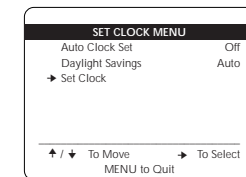
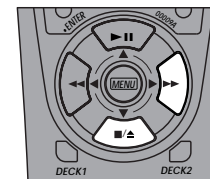

**Note that the Set Clock Menu changes when you turn Auto Clock Set "On" or "Off."*

Y2K Compliant

This Dual-Deck VCR is fully compliant with the calendar year 2000. Note that the year 2000 is a leap year.

5 Set the Time

Use the number keys or the up/down arrow keys to set each of the following items. To skip an item, press the right arrow key:

- **Set Month** — Enter the month as a 2-digit number; e.g. January = "01"
- **Set Year** — Enter the year as a 2-digit number; e.g. 2000 = "00"
- **Set Day** — Enter the day as a 2-digit number; e.g. the ninth = "09"
- **Set Hour** — Enter the hour as a 2-digit number; e.g. 12:xx = "12"
- **Set Minute** — Enter the minute as a 2-digit number; e.g. xx:25 = "25"
- **Set AM/PM** — Press "1" for AM, "2" for PM

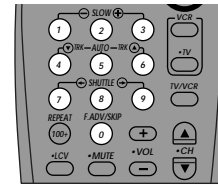

or

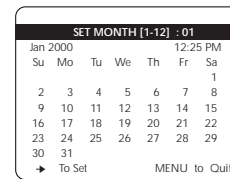
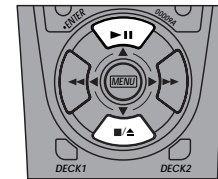

— SET MONTH [1-12]
— SET YEAR [00-99]
— SET DAY [1-31]
— SET HOUR [1-12]
— SET MINUTE [0-59]
— SET AM/PM [1/2]

6 Save Settings

The Clock is set! Press the Menu button at any time to save and exit the menu system.

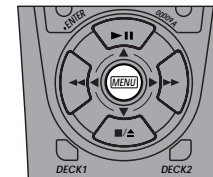

Set Daylight Savings Time

From the Set Clock Menu, you may also choose to manually set Daylight Savings Time, your Time Zone, or the Auto Clock Set channel.

1 Open the "Setup Menu"

Press and hold the menu button for 3 seconds.

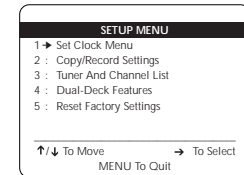
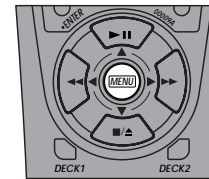

2 Open the "Set Clock Menu"

Press 1.

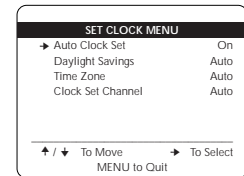
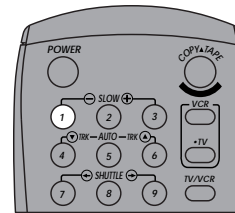

3 Choose "Daylight Savings"

Press the down arrow key until "Daylight Savings" is selected. Note: If Auto Clock Set is Off, the menu at right will show different choices.

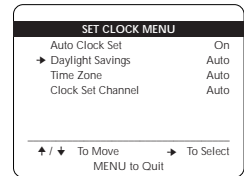
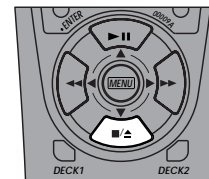

4 Set "Daylight Savings"

Press the right arrow key to select one of the following options:

- **Auto** — Uses local channel information to determine the status of Daylight Savings Time in your area.
- **Off** — Disables the Daylight Savings adjustment, i.e. the time never changes.
- **On** — Enables Daylight Savings at 2:00 AM on the first Sunday of April, and disables it at 2:00 AM on the last Sunday in October.

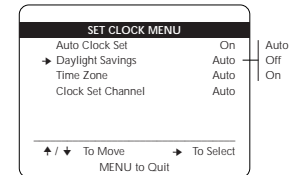
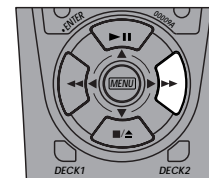

Set Time Zone

You can manually set the Time Zone for your region. Use this feature if Auto Clock Set has incorrectly set the time by detecting a nearby time zone. Note: If you are an Arizona resident, choose Mountain Standard Time and turn Daylight Savings Time off.

1 Open the "Setup Menu"

Press and hold the menu button for 3 seconds.

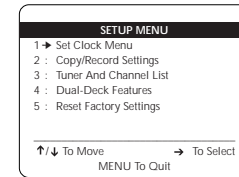
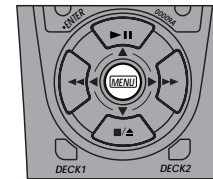

2 Open the "Set Clock Menu"

Press 1.

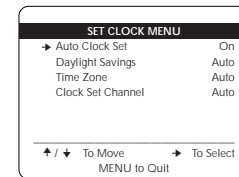
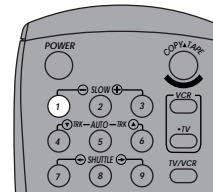

3 Select "Time Zone"

Press the down arrow key until "Time Zone" is selected. Note: Make sure Auto Clock Set is set to "On" or Time Zone will not be listed.

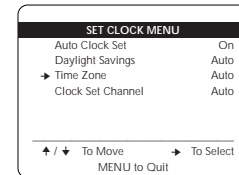
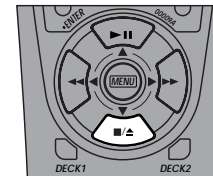

4 Set "Time Zone"

Press the right arrow key to select one of the following options:

- **Auto** — Automatically detects the local Time Zone
- **Eastern** — Selects Eastern Standard Time
- **Central** — Selects Central Standard Time
- **Mountain** — Selects Mountain Standard Time
- **Pacific** — Selects Pacific Standard Time
- **Alaska** — Selects Alaska Standard Time
- **Hawaii** — Selects Hawaii Standard Time

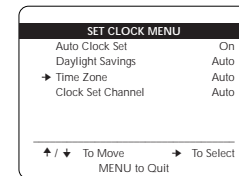
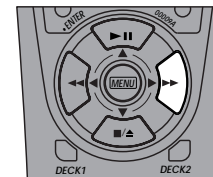

Set Auto Clock Set Channel

If you know a station in your area that broadcasts time information, you can set the Auto Clock Set Channel manually. For example, your local PBS station will usually transmit the time and date. Use this feature only if Auto Clock Set has set the time incorrectly.

1 Open the "Setup Menu"

Press and hold the menu button for 3 seconds.

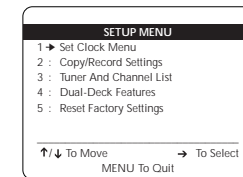
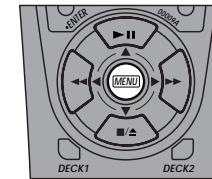

2 Open the "Set Clock Menu"

Press 1.

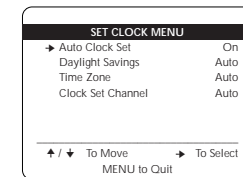
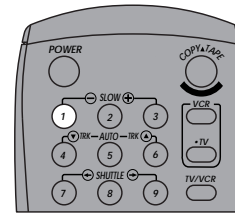

3 Select "Clock Set Channel"

Press the down arrow key until "Clock Set Channel" is selected. Note: Make sure Auto Clock Set is set to "On" or Clock Set Channel will not be listed.

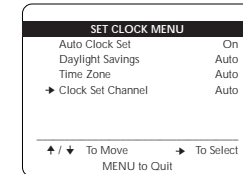
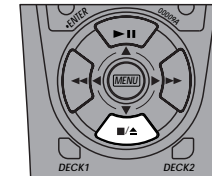

4 Set "Clock Set Channel"

Press the right arrow key to select one of the following options:

- **Auto** — Automatically searches for a local channel broadcasting the time via XDS (Extended Data Services)
- **Ch ##** — Allows you to manually set a channel which you know to receive XDS information. Use the 0-9 keys to set the desired channel.
- **Aux** — Allows the clock to be set from another AV (Audio/Video) device attached to your VCR's front auxiliary input.

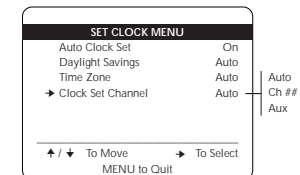
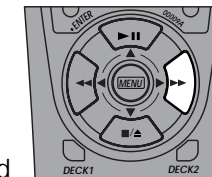

3 - The Dual-Deck System

Remote Control Overview

***Power** — Turns the VCR on and off. Note: Power will come on automatically when you insert a videotape (Auto Power On).

Slow +/- — In Play mode, increases or decreases the speed of slow motion playback.

***0-9** — Selects channels directly. In the Menu system, selects menu items.

Trk ▲▼, Auto — In Play mode, allows you to manually adjust tracking. Press Auto to resume Auto Tracking.

Shuttle — In Play mode, Shuttle → gradually increases the playback speed from double-speed playback to picture search to jet search. Shuttle ← gradually slows down the tape, pauses, then goes into reverse picture search and reverse jet search.

***100+** — Selects cable channels 100 and up.

***LCV (Last Channel Viewed)** — Displays the previously selected channel.

* Keys marked with an asterisk can be used to operate your TV or VCR; see Appendix A to program your remote control.

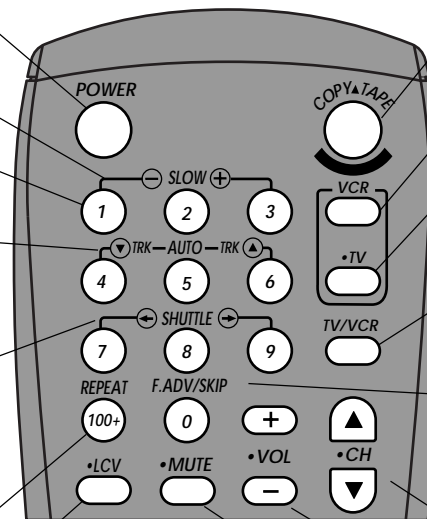

Copy Tape — Copies the tape in Deck 1 to the tape in Deck 2.

VCR — Sets the remote to operate your VCR.

TV — Sets the remote control to operate your television. Note: When selected, the remote will not operate the VCR. To program the remote, see Appendix A.

TV/VCR — Switches between your TV's tuner and your VCR's tuner; e.g., press when you are taping a show with the VCR and you want to watch another station on your television.

F.Adv/Skip — In Pause mode, advances the tape one frame for every press. In Play mode, jumps ahead one minute for every press (up to 5 minutes). In Copy mode, skip edits one minute for every press (up to 5 minutes).

***Channel ▲▼** — Changes channels up and down.

***Volume +/-** — Adjusts the sound level.

***Mute** — Turns audio on and off.

Top Section

TV View — Changes your view on the television between the Tuner, Deck 1, Deck 2 and Aux. This allows you to quickly jump between a TV show, videotape, DVD, etc.—at the touch of a button.

Scene/Title — Marks the beginning and ending points of scenes in the 8-Scene Editor. Also press to record On-Screen Titles.

Rec — Starts recording in the active deck. Press twice to activate One-Touch Recording.

Set Timer — Opens the Timer Recording Setup Menu.

SP/SLP — Sets the record speed to SP (Standard Play) or SLP (Super Long Play). SLP is three times longer than SP.

Rew — When the tape is stopped, rewinds the tape. When the tape is playing, visually searches the tape in reverse (Review).

Deck1 — Sets Deck 1 as the active deck. All deck control buttons (Play, Rewind, etc.) will only affect Deck 1.

Search/Index — From Stop, Play, F.Forward, or Rewind, opens the Search/Index Menu. While recording, places an Index mark on the tape.

Clear — Resets the Tape Counter to 0:00:00. Also clears certain entries in the menu system.

Display — Turns the On-Screen Display (Clock, Tuner, Audio, and Deck status) on and off.

CLK/CTR — Changes the Front Panel Display between clock, tape counter, and time remaining.

Play/Still — Plays the tape. In Play or Record mode, pauses the tape in the source deck.

F.F. — When the tape is stopped, fast-forwards the tape. When the tape is playing, visually searches the tape forward (Cue).

Menu — Opens the Main Menu. Press and hold for three seconds to open the Setup Menu

Stop/Eject — Stops the tape in the active deck. Press twice to eject the tape.

Deck2 — Sets Deck 2 as the active deck. All deck control buttons (Play, Rewind, etc.) will only affect Deck 2.

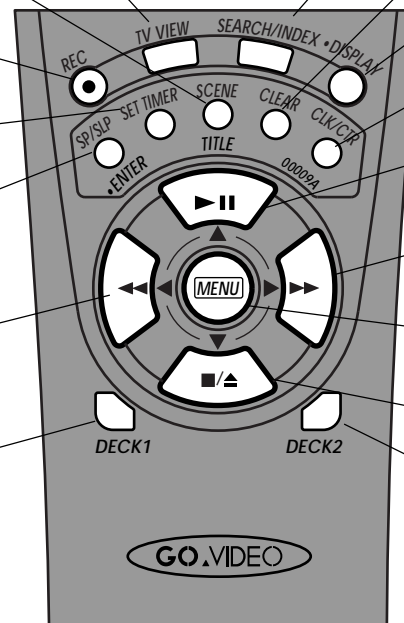

Deck Control Section

Front Panel Overview

Power — Turns the VCR on and off. Note: Power will come on automatically when you insert a videotape.

Pause — Pauses the tape playing or recording in the active deck.

Play — Plays the tape in the active deck. Press twice for Still. In menus, moves selection arrow up.

Record — Starts recording in the active deck. Press repeatedly to activate One-Touch Recording.

TV/VCR — Switches between the TV's tuner and the VCR's tuner.

Copy Tape — Copies the tape in Deck 1 to Deck 2.

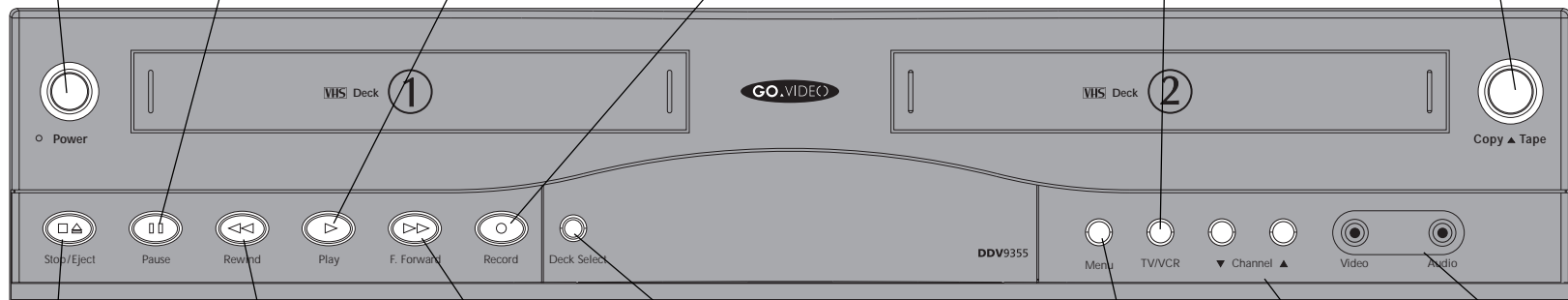

Stop/Eject — Stops the tape in the active deck. Press twice to eject the tape. In menus, moves selection arrow down.

Rewind — In Stop mode, rewinds the tape. In Play mode, visually searches the tape in reverse (Review). In menus, backs up one menu.

F.Forward — In Stop mode, fast-forwards the tape. In Play mode, visually searches the tape forward (Cue). In menus, selects and cycles through menu items.

Deck Select — Switches control between Deck 1 and Deck 2.

Menu — Opens the Main Menu. Press and hold for 3 seconds to open the Setup Menu.

Channel Up/Down — Changes channels up and down.

See next page...

Note: Front panel is shown with flap door open

Front Panel Auxiliary Input

Use the Front Panel Auxiliary Input for easy connection to a camcorder or video game using standard RCA cables. Throughout the menu system, the front panel input is referred to as "Aux."

Audio Input (White) — Use to connect the monaural (mono) audio signal from an external device, such as a camcorder or videogame, using an RCA cable.

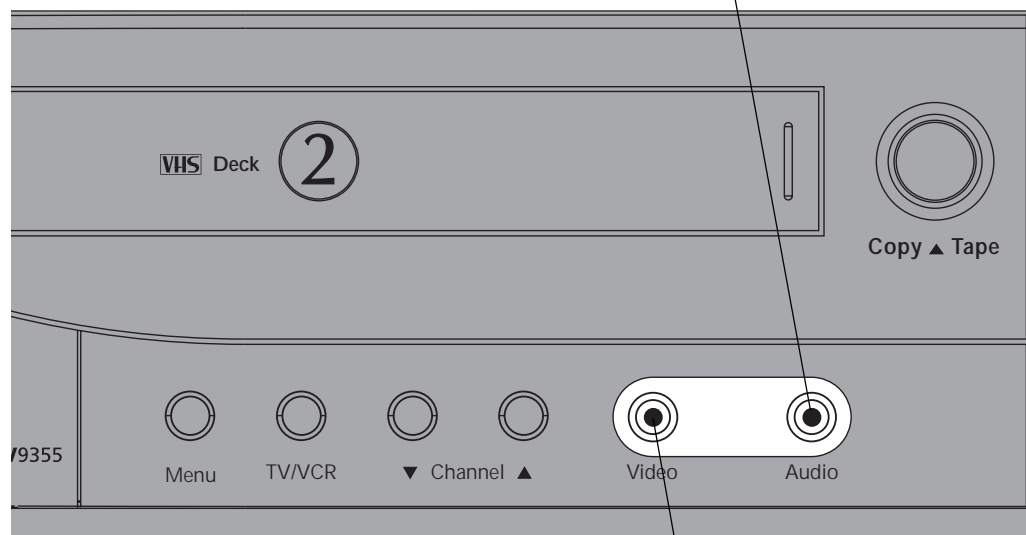

Video Line Input (Yellow) — Use to connect the video signal from an external device, such as a camcorder or videogame, using an RCA cable.

Front Panel Display

The Front Panel Display shows you the current status of your Dual-Deck VCR.

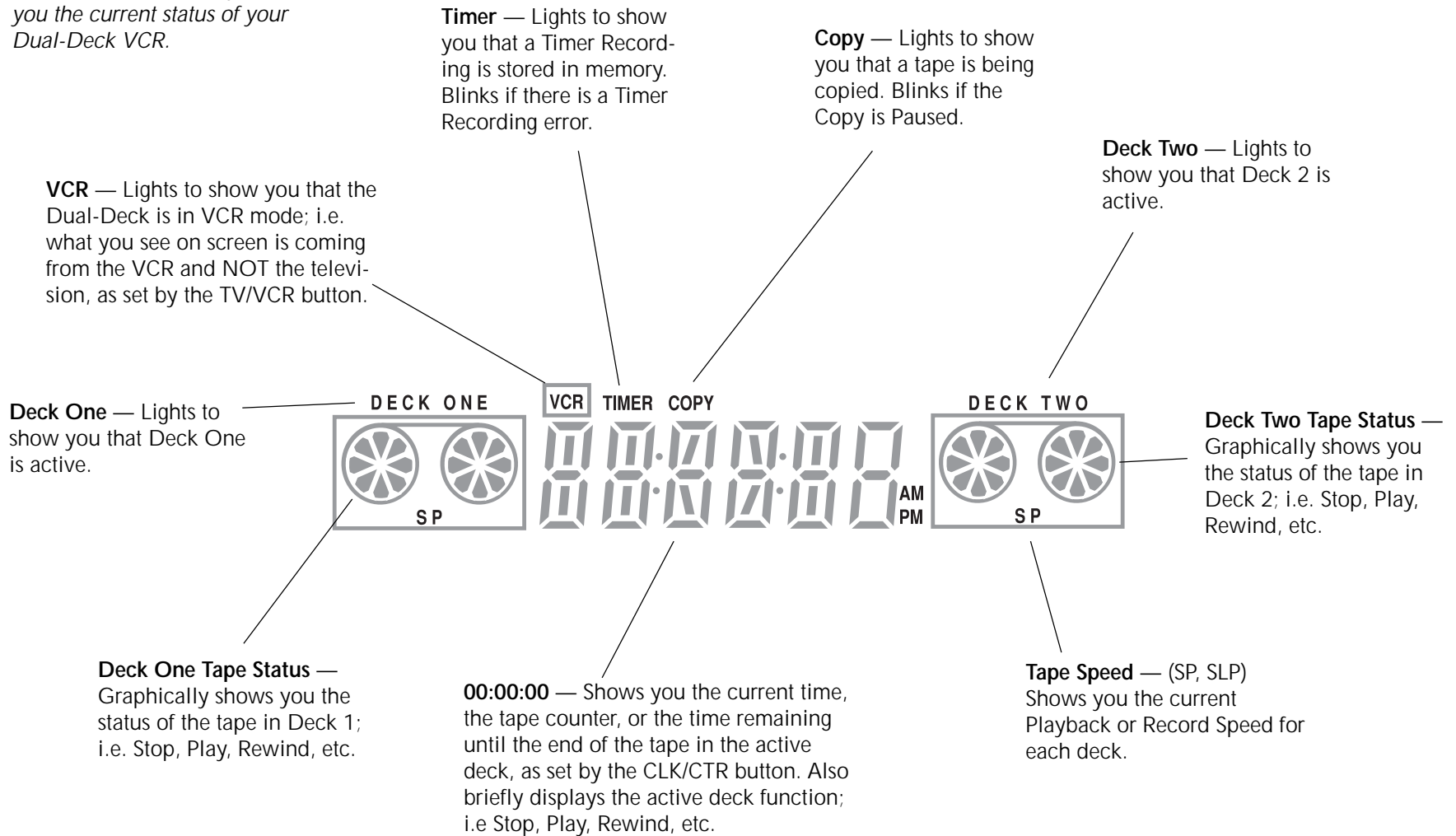

Front Panel Display Settings

You can turn the Front Panel Display permanently on or off, or you may choose to have it automatically dim at night so it doesn't keep you awake.

1 Open "Setup Menu"

Press and hold the Menu button for 3 seconds.

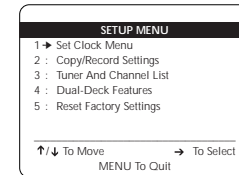
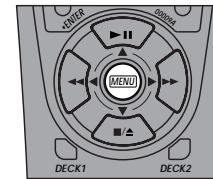

2 Select "Dual-Deck Features"

Press 4.

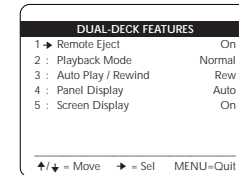
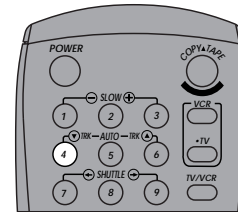

3 Set "Panel Display"

Press 4 to select one of the following options:

- **Auto** — Dims the Front Panel Display automatically between 10:00 PM and 6:00 AM.
- **On** — Makes the Front Panel Display bright at all times.
- **Off** — Disables the Front Panel Display

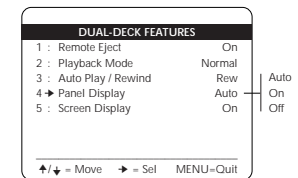
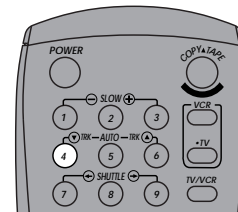

Child Lock

To prevent children from tampering with the front panel buttons while you're watching a movie, or using the VCR when you are away, you can activate the Child Lock feature. This feature disables Auto Power On, Auto Play, and all front panel buttons. Once the Child Lock is set, you will need the remote control to operate the VCR.

1 Open "Main Menu"

Press the Menu button on the remote control.

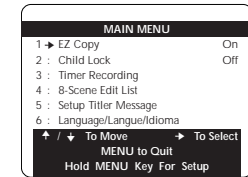
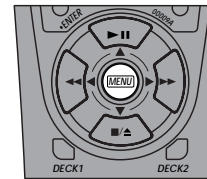

2 Set "Child Lock"

Press 2 repeatedly to turn Child Lock "On" or "Off."

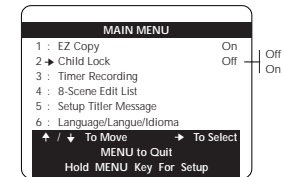
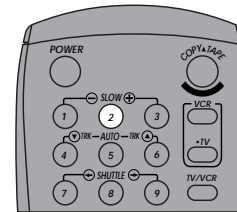

With Child Lock set to "On":

- **Auto Power On is disabled** - The VCR will not turn on automatically when a tape is inserted.
- **Auto Play is disabled** - Tapes will not play automatically when you insert them, regardless of the Auto Play setting (see page 45).
- **Front panel buttons are disabled** - You will still be able to use the remote control to operate all VCR functions.

Remote Eject

With Remote Eject enabled, you can eject videotapes by pressing the Stop button on the remote control.

1 Open "Setup Menu"

Press and hold the Menu button for 3 seconds.

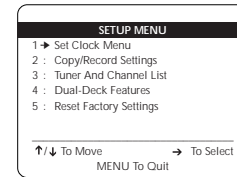
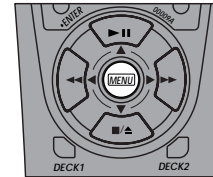

2 Select "Dual-Deck Features"

Press 4.

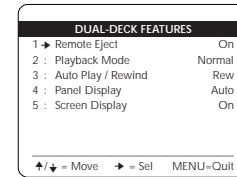
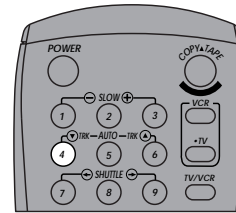

3 Set "Remote Eject"

Press 1 repeatedly to turn Remote Eject "On" or "Off."

- **On** — Allows you to eject tapes by pressing the Stop button on the remote control.
- **Off** — To eject tapes, you must use the Stop/Eject button on the VCR's front panel.

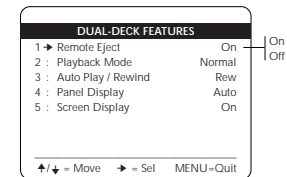
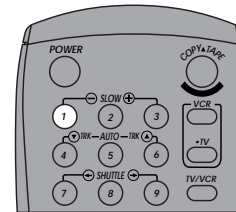

Main Menu Tree

The On-Screen Menu System is the control center for your Dual-Deck VCR. It is divided into two sections:

- **Main Menu** — Use for everyday functions, such as EZ Copy, Child Lock, and Timer Recording.
- **Setup Menu** — Use for “set and forget” options, like Set Clock, Copy/Record Settings and Tuner & Channel List.

To access the Main Menu, press and release the Menu button.

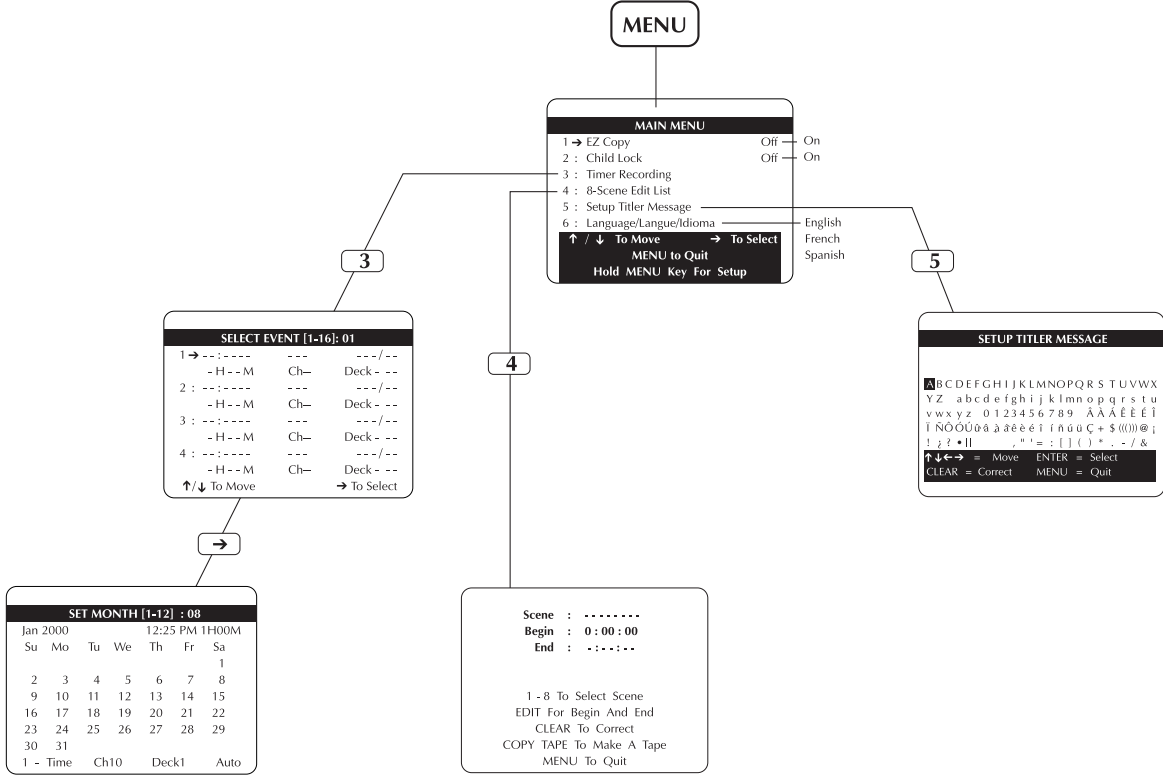

Setup Menu Tree

The Setup Menu includes a variety of advanced options that allow you to customize your Dual-Deck VCR in virtually unlimited ways. Don't forget to press and HOLD the Menu button for 3 seconds to access the Setup Menu.

To access the Setup Menu, press and HOLD the Menu button for 3 seconds.

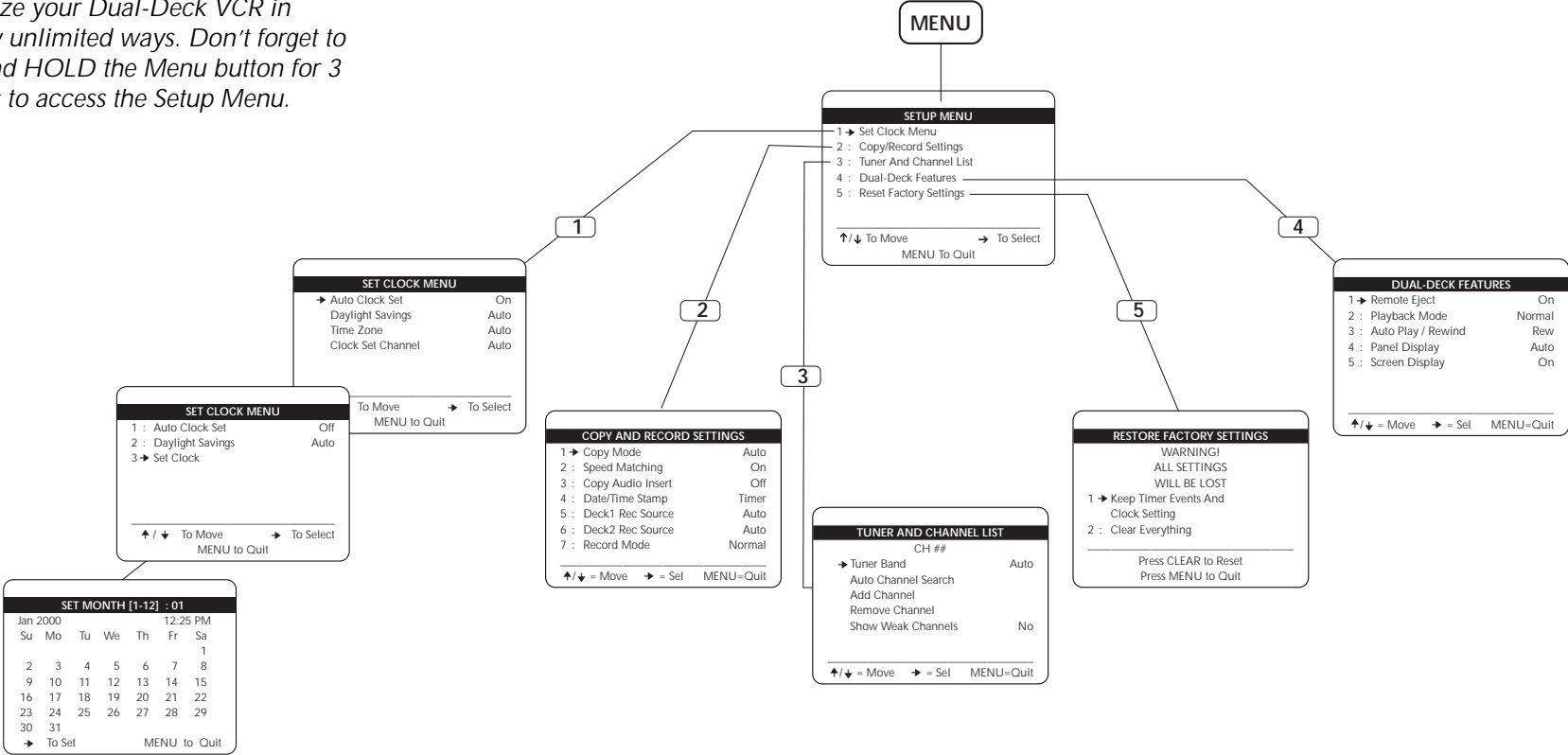

Menu Navigation - Remote Control

Use the following remote control buttons to enter and navigate within the Dual-Deck menu system.

Menu

Press and release to enter the Main Menu and adjust everyday functions. While in the menu system, press to save settings and exit.

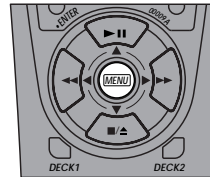

Right Arrow

Press to select and cycle through menu items.

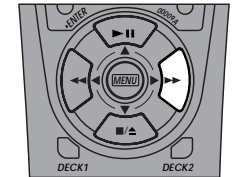

Menu (3 seconds)

Press and hold for 3 seconds to enter the Setup Menu and adjust "set and forget" functions.

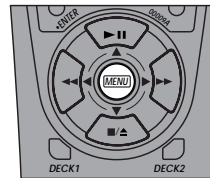

0-9

Direct method of selecting and changing menu items (used in the examples throughout this manual).

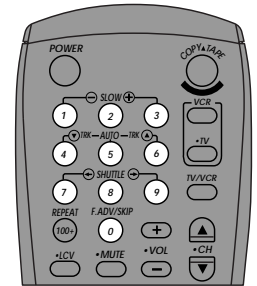

Up/Down Arrows

Press to move up or down the list of menu items.

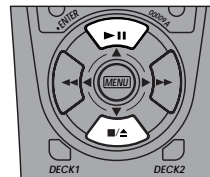

Clear

Press to cancel certain selections in the menu system.



Left Arrow

While in the menu system, press to go back to the previous menu.

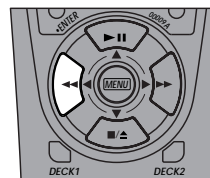

Menu Navigation - Front Panel

The following front panel buttons can also be used to enter and navigate within the menu system.

Menu

Press and release to enter the Main Menu and adjust everyday functions. While in the menu system, press to save settings and exit.

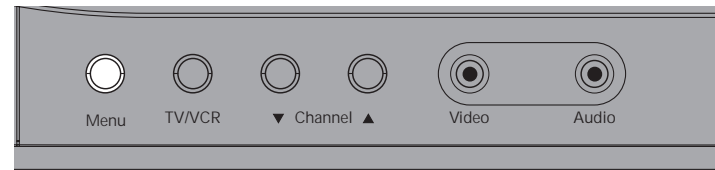

Menu (3 seconds)

Press and hold for 3 seconds to enter the Setup Menu and adjust "set and forget" functions.



Stop/Eject & Play

Press Stop/Eject to move down and Play to move up the list of menu items.



Rewind

While in the menu system, press to go back to the previous menu.

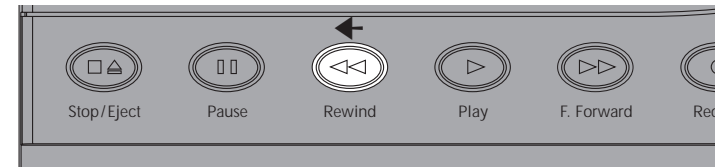

F.Forward

Press to select and cycle through menu items.



Reset Factory Settings

If you make changes to the Dual-Deck VCR default settings, you can always restore the original factory settings. If you wish, you can choose to retain the clock and timer record settings.

1 Open "Setup Menu"

Press and hold the Menu button on the remote control for 3 seconds.

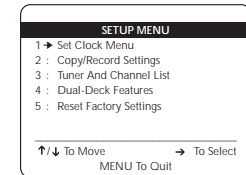
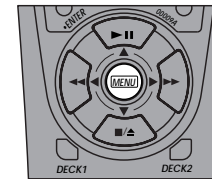

2 Select "Reset Factory Settings"

Press 5.

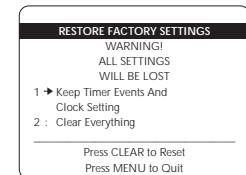
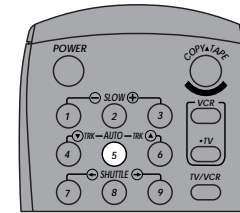

3 Decide What to Reset

Press "1" if you want to reset everything except the clock and any saved Timer Recordings.
Press "2" if you want to clear all settings.

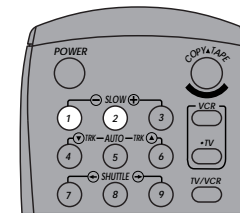

4 Restore Settings

Press the Clear button to confirm your decision and restore factory settings.

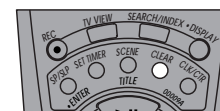

On-Screen Display Overview

The On-Screen Display (OSD) shows you the status of the Dual-Deck VCR at any given moment, including information from the Tuner, Decks, and Aux input. It also displays the Date & Time, and communicates important Copy, Timer Record, and Error messages.

Note: The OSD will appear whenever you activate a Deck function, e.g. play a tape, change channels, etc. It will turn off automatically after 5 seconds.

1 View On-Screen Display

Press Display.

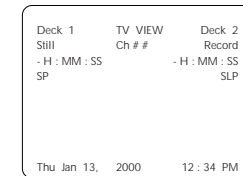
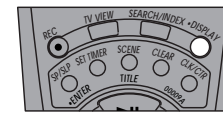

2 Change View

Press TV View repeatedly to cycle through the On-Screen Displays for each of the five view sources:

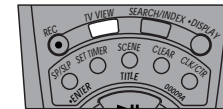

- **Tuner** - Displays the channel and audio status for the TV show you are watching.
- **Aux** - Displays the output from a device, such as a camcorder or videogame, connected to the front line input.
- **Deck 1** - Displays the status of the tape in Deck 1.
- **Deck 2** - Displays the status of the tape in Deck 2.

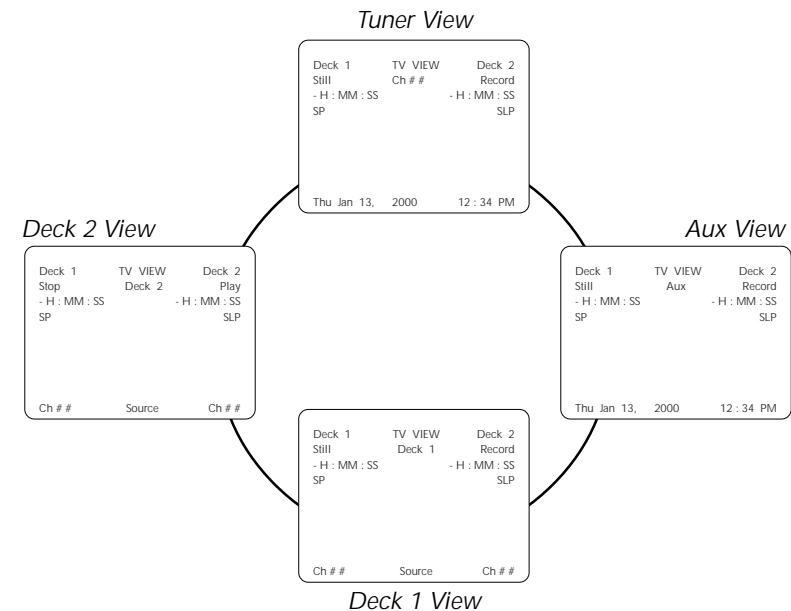

On-Screen Display Elements

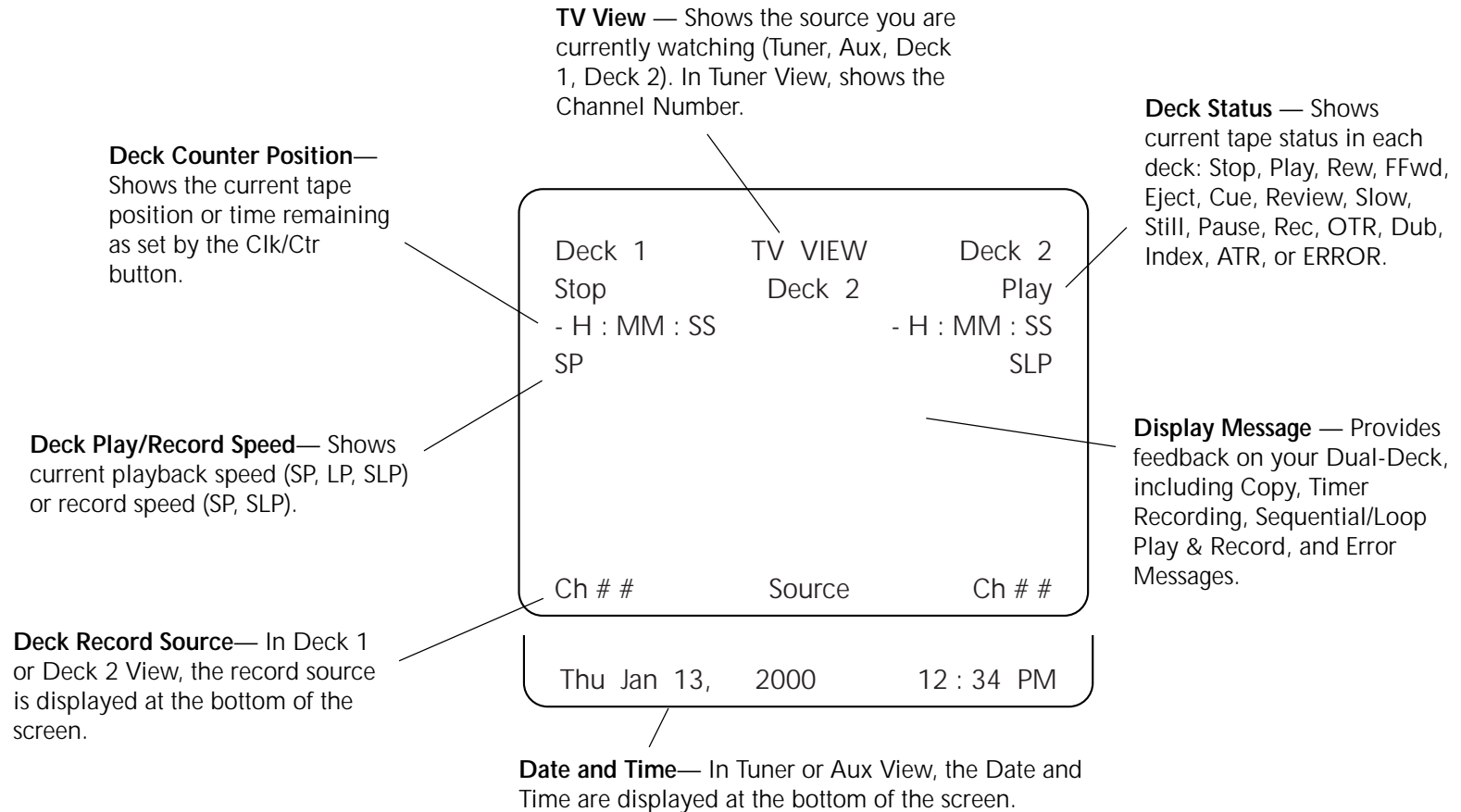

On-Screen Display (OSD) Settings

You can customize the OSD to show only Tuner information, only Deck information, or have it turned off at all times unless you press the Display key.

1 Open "Setup Menu"

Press and hold the Menu button on the remote control for 3 seconds.

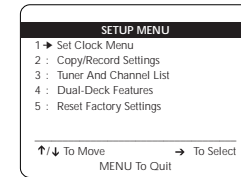
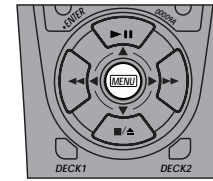

2 Select "Dual-Deck Features"

Press 4.

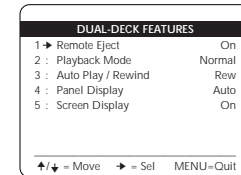
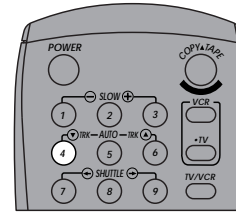

3 Set "Screen Display"

Press 5 to set Screen Display to one of the following options:

- **On** — Displays the complete OSD whenever a Tuner or Deck function is activated (i.e., Play, Stop, Channel ▲▼, etc.).
- **Off** — Turns the OSD off permanently unless you press the Display button.
- **Auto** — Displays Tuner information when a Tuner function is activated (e.g., Channel ▲▼), and Deck information when a Deck function is activated (e.g., Play, Stop). To view the full display, press the Display button.

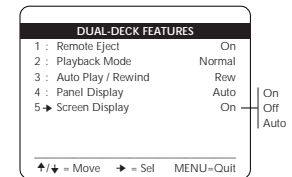
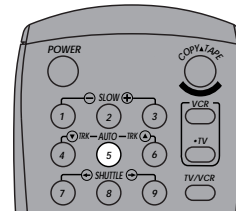

4 - Tuner & Channel List

Tuner Band

Broadcast television comes into your home from one of two sources: over the air via antenna, or through a cable via a local CATV (Community Antenna Television) provider or Satellite. The Tuner Band setting allows you to specify which source you are using. Use this setting only if Auto Setup detected the incorrect band, i.e. channels are coming in on the wrong channel numbers.

1 Open "Setup Menu"

Press and hold the Menu button for 3 seconds.

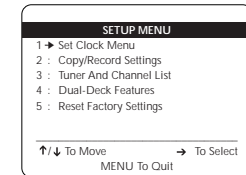
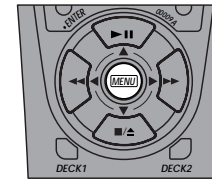

2 Select "Tuner & Channel List"

Press 3.

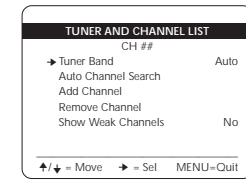
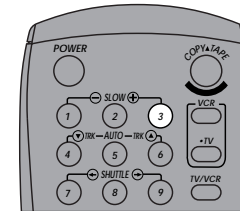

3 Set "Tuner Band "

Press the right arrow to select from the following options:

- **Auto** — Automatically detects the Tuner Band.
- **Antenna** — Specifies that you are using an indoor or outdoor VHF/UHF antenna.
- **Cable** — Specifies that you are using either Community Antenna Television (CATV, or cable) or a Satellite receiver.

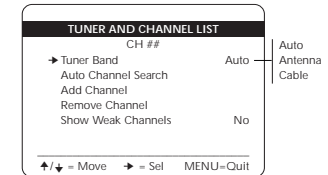
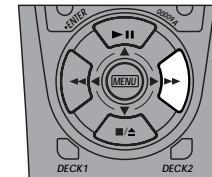

Auto Channel Search

Auto Channel Search tests every channel and stores only those which can be viewed clearly in your area. See the following pages to add or remove channels, or to display channels with weaker signals.

1 Open "Setup Menu"

Press and hold the Menu button for 3 seconds.

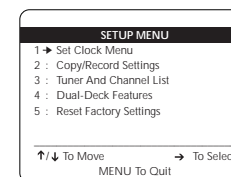
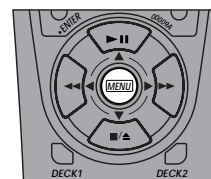

2 Select "Tuner & Channel List"

Press 3.

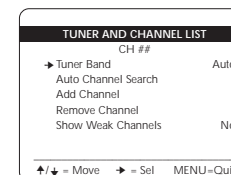
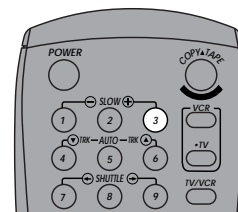

3 Select "Auto Channel Search"

Press the down arrow until Auto Channel Search is selected.

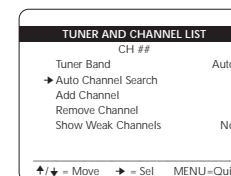
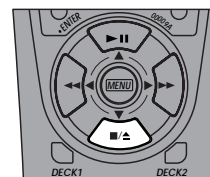

4 Start "Auto Channel Search"

Press the right arrow to automatically search for all available channels in the selected Tuner Band. This procedure may take a few minutes to complete. When Auto Channel Search is finished, it will display the lowest channel found.

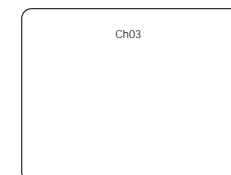
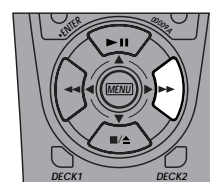

Add Channel

Follow these steps to add any channels that were not detected during Auto Channel Search.

1 Open "Setup Menu"

Press and hold the Menu button for 3 seconds.

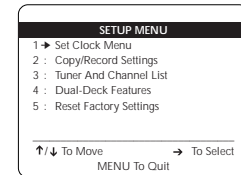
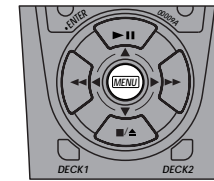

2 Select "Tuner & Channel List"

Press 3.

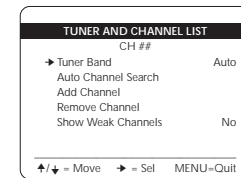
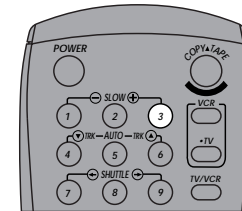

3 Select "Add Channel"

Press the down arrow until Add Channel is selected.

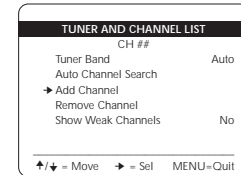
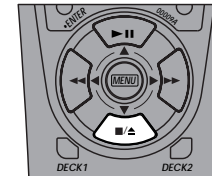

4 Tune the Channel

Use the number keys (0-9) to enter the channel number, e.g. "1-1" for Channel 11.

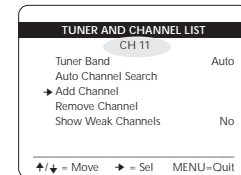
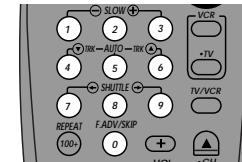

5 Add the Channel

Press the right arrow to add the channel to your channel list. Repeat steps 4 and 5 to add more channels.

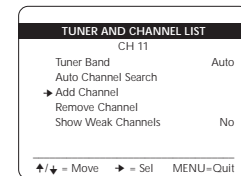
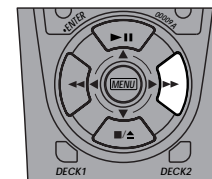

Remove Channel

Follow these steps to remove any channels that were stored during Auto Channel Search.

1 Open "Setup Menu"

Press and hold the Menu button for 3 seconds.

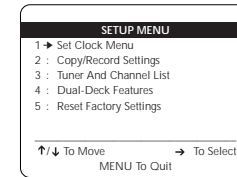
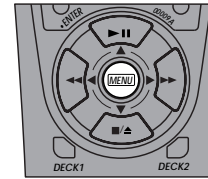

2 Select "Tuner & Channel List"

Press 3.

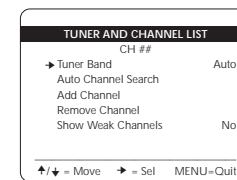
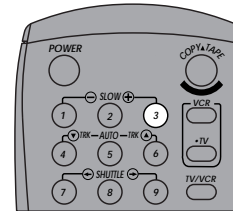

3 Select "Remove Channel"

Press the down arrow until Remove Channel is selected.

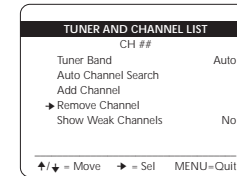
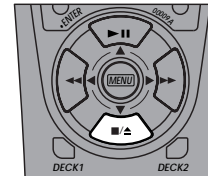

4 Tune the Channel

Use the channel up/down arrows or the number keys (0-9) to enter the channel you wish to remove.

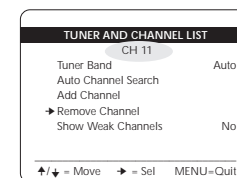
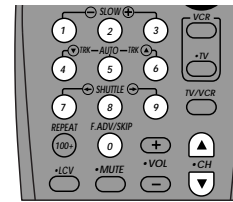

5 Remove the Channel

Press the right arrow to remove the selected channel from your channel list. Repeat steps 4 and 5 to remove additional channels.

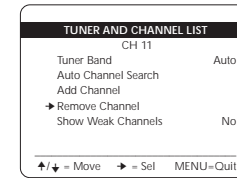
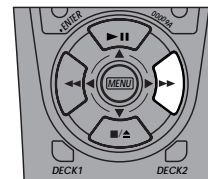

Show Weak Channels

Show Weak Channels disables the blue screens that normally appear when you select a channel with weak reception. If you manually add a channel that Auto Channel Search missed, you will want to set Show Weak Channels to "Yes" so you can view the channel instead of a blue screen.

1 Open "Setup Menu"

Press and hold the Menu button for 3 seconds.

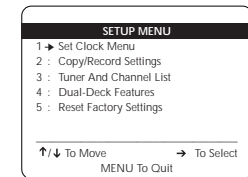
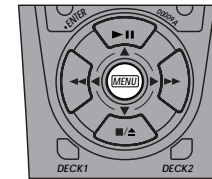

2 Select "Tuner & Channel List"

Press 3.

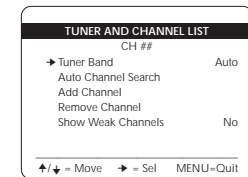
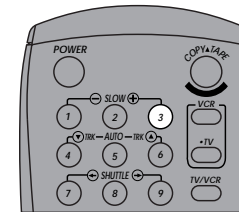

3 Select "Show Weak Channels"

Press the down arrow until Show Weak Channels is selected.

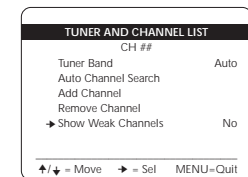
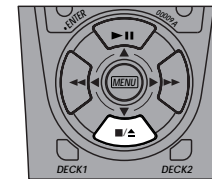

4 Set "Show Weak Channels"

Press the right arrow repeatedly to set Show Weak Channels to "Yes" or "No." If you choose "Yes," return to page 30 and run Auto Channel Search again.

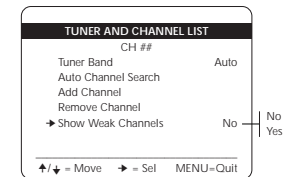
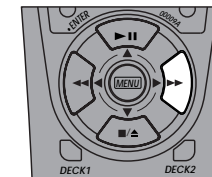

5 - Copy Features

Basic Copying

Copying a videotape has never been easier. Simply insert your source tape in Deck 1, your blank tape in Deck 2, and press Copy Tape. No wires, no hassle, and perfect copies every time.

Note: The Dual-Deck VCR cannot duplicate copy-protected tapes. If you try to copy a protected tape, the message "Tape is Copy Protected" will appear on the on-screen display.

1 Insert Source Tape

Put the tape you wish to copy in Deck 1 on the left side of the VCR.



2 Insert Target Tape

Put your blank tape in Deck 2 on the right side of the VCR.



3 Copy Your Tape

Press the Copy Tape button on either the remote control or the front of the VCR. The tape in Deck 1 will begin copying to Deck 2.

- To pause copying, press Copy Tape.
- To resume copying, press Copy Tape again.
- To stop copying, press Stop/Eject on Deck 2.
- To have both decks automatically rewind before and after copying, see EZ Copy on page 36.

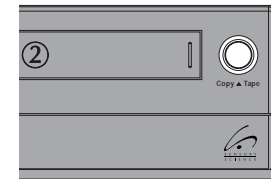
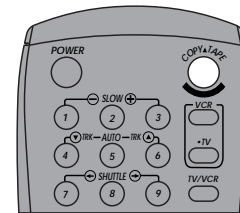

EZ Copy

Turn on EZ Copy to make tape duplication even easier. When you press Copy Tape, the VCR will rewind both decks completely, copy the source tape to the target tape, rewind both decks, and eject the tapes—all at the touch of a button!

1 Open “Main Menu”

Press the Menu button on the remote control.

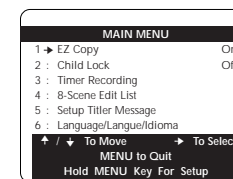
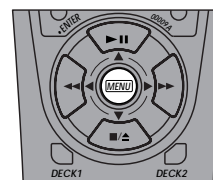

2 Set “EZ Copy”

Press 1 to select from the following options:

- **On** — When you press Copy Tape, both decks will rewind, the tape in Deck 1 will be copied to Deck 2, both decks will rewind again, and the tapes will eject. Complete Program Record will activate to ensure the maximum amount of tape is copied before the tape runs out (see note).

Note: If the tape runs out in Deck 2 before copying is complete, neither tape will rewind to alert you that a problem occurred.

- **Off** — EZ Copy is disabled. See Basic Copying on page 35.

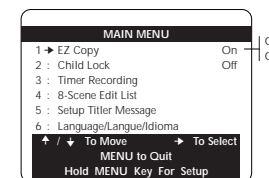
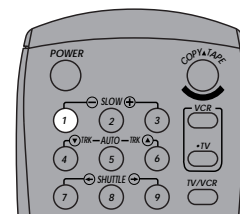

Complete Program Record

Complete Program Record, or CPR, helps to ensure you won't run out of tape before your copy is complete. When EZ Copy is selected, the VCR begins copying at the same speed as the source tape; it then calculates how much time is remaining on the target tape and adjusts the copy speed to SLP if necessary to copy the entire tape. If there is not enough room to copy the entire source tape, the VCR will copy in SLP until the end of the target tape is reached.

Copy Mode

There are two methods of copying a tape from Deck 1 to Deck 2: HQ1 (High Quality 1) and HQ2 (High Quality 2). HQ1 is best if your source tape is recorded in SP. HQ2 is best if your source tape is recorded in LP or SLP. The Auto setting will make this choice for you.

1 Open "Setup Menu"

Press and hold the Menu button for 3 seconds.

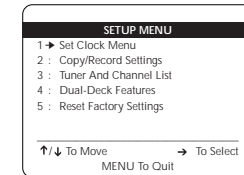
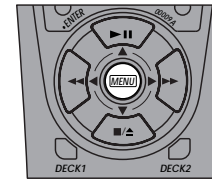

2 Select "Copy/Record Settings"

Press 2.

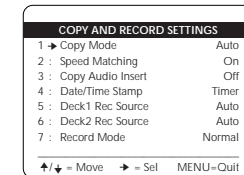
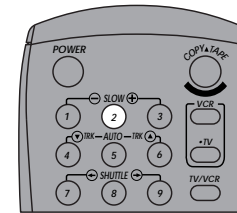

3 Set "Copy Mode"

Press 1 to choose from the following options:

- **Auto** — Sets the Copy Mode automatically.
- **HQ1** — Copies in High Quality 1 mode, the best choice if your source tape is recorded in Standard Play (SP) mode.
- **HQ2** — Copies in High Quality 2 mode, the best choice if your source tape is recorded in Long Play (LP) or Super Long Play (SLP) mode.

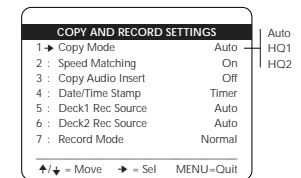
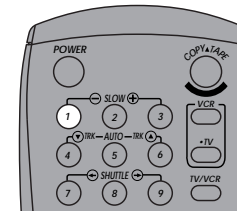

Speed Matching

Speed Matching automatically sets the Deck 2 record speed to be the same as the Deck 1 playback speed when copying a tape. You will typically get the best results with this feature turned on. You must disable this feature to copy multiple movies onto a single blank tape.

1 Open "Setup Menu"

Press and hold the Menu button for 3 seconds.

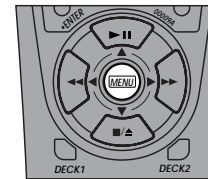

SETUP MENU	
1	→ Set Clock Menu
2	: Copy/Record Settings
3	: Tuner And Channel List
4	: Dual-Deck Features
5	: Reset Factory Settings
↑/↓ To Move → To Select	
MENU To Quit	

2 Select "Copy/Record Settings"

Press 2.

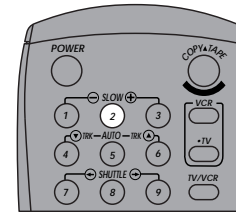

COPY AND RECORD SETTINGS	
1	→ Copy Mode Auto
2	: Speed Matching On
3	: Copy Audio Insert Off
4	: Date/Time Stamp Timer
5	: Deck1 Rec Source Auto
6	: Deck2 Rec Source Auto
7	: Record Mode Normal
↑/↓ = Move → = Sel MENU = Quit	

3 Set "Speed Matching"

Press 2 to set Speed Matching to "On" or "Off." Only turn Speed Matching off if you want to record two or three SP tapes onto one SLP tape. If so, you will also need to manually set the Record Speed to SLP; see page 50.

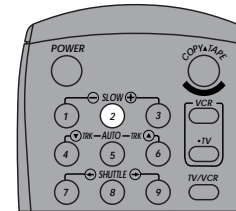

COPY AND RECORD SETTINGS	
1	: Copy Mode Auto
2	→ Speed Matching On
3	: Copy Audio Insert Off
4	: Date/Time Stamp Timer
5	: Deck1 Rec Source Auto
6	: Deck2 Rec Source Auto
7	: Record Mode Normal
↑/↓ = Move → = Sel MENU = Quit	

Copy Audio Insert

While you are copying a tape, you can insert a new audio track, such as recorded music or narration, onto your target tape. The new audio will be recorded from the front aux inputs.

1 Open "Setup Menu"

Press and hold the Menu button for 3 seconds.

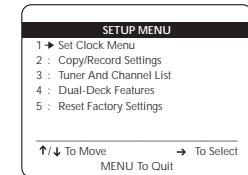
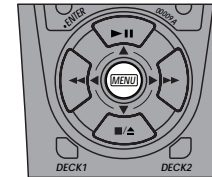

2 Select "Copy/Record Settings"

Press 2.

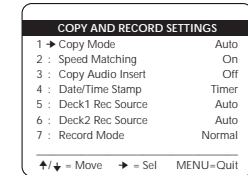
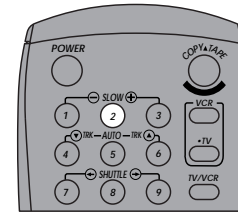

3 Set "Copy Audio Insert"

Press 3 to select from the following options:

- **Off** — Copy Audio Insert is disabled. No new audio track will be recorded.
- **Aux** — While you are copying a tape, a new audio track will be recorded from an external audio source connected to the front audio jacks.

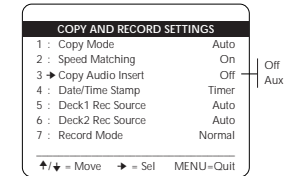
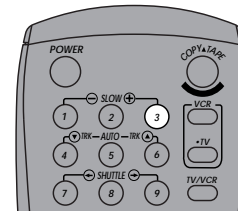

6 - Playback Features

Basic Playback

To play a videotape, simply insert it in either deck and press the Play button. Tapes without Record Safety Tabs can be set to play automatically when inserted; see page 45.

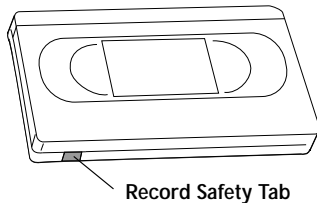

1 Insert Tape

Insert a standard VHS tape into Deck 1 or Deck 2.



2 Play Tape

Press Play on the remote control or the front panel.

Notes: If the tape is missing the Record Safety Tab and Auto Play is turned on, the tape will begin to play automatically.

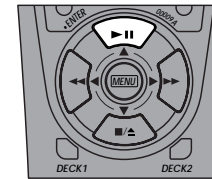

Or

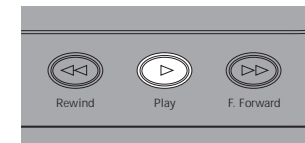

Special Playback Features

While a tape is playing, you can enjoy a variety of special playback features, including Freeze, Slow Motion, Skip, Repeat, and more. Press the Play button again to resume normal playback.

Freeze Frame

From Play mode, press Play/Still to freeze a single frame.

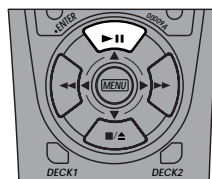

Frame Advance

From Still mode, press F.Adv/Skip to advance to the next frame.



Slow Motion

From Play mode, press Slow +/- for Slow Motion playback at variable speeds.

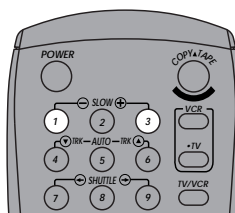

Cue

From Play mode, press F.Forward to cue at two speeds:

- **Picture Search** — Press and release F.Forward to advance the tape at 5 times normal speed.
- **Jet Search** — Press and hold F.Forward to advance the tape at 7 times normal speed.

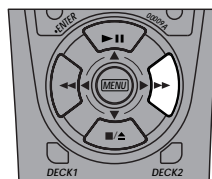

Review

From Play mode, press Rewind to review at two speeds:

- **Picture Search** — Press and release Rewind to review the tape at 5 times normal speed.
- **Jet Search** — Press and hold Rewind to review the tape at 7 times normal speed.

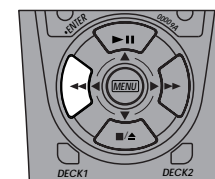

Skip

From Play mode, press F.Adv/Skip repeatedly up to 5 times to cue ahead 1-5 minutes.



Repeat

From Play mode, press Repeat to review the last 30 seconds of tape.

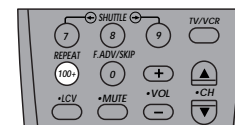

Shuttle

From Play mode, Shuttle → gradually increases the cue speed from Double-Speed playback to Picture Search to Jet Search. Shuttle ← gradually slows down the tape, Pauses, then goes into Reverse Picture Search and Reverse Jet Search.

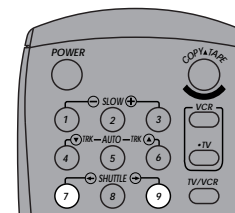

Tracking

The Tracking adjustment removes the white lines that sometimes appear during playback because of slight differences in recording decks. The Auto Tracking button (Auto) will automatically align the recorded tracks with the playback heads to solve this problem. You may also set tracking manually.

1 Adjust Tracking Manually

During playback, press the TRK up/down arrow keys to move the white lines out of the picture.

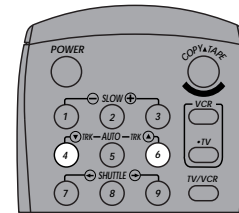

2 Resume Auto Tracking

Press Auto to have the VCR adjust tracking automatically.

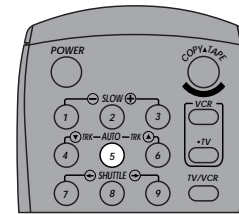

Sequential/Loop Playback

You can insert two tapes in your Dual-Deck VCR and have them play sequentially or in a continuous loop. For example, you may rent a movie that comes on two videotapes and watch them seamlessly one after the other. You may also set two sales or training tapes to play in a continuous loop.

1 Open "Setup Menu"

Press and hold the menu button on the remote control for 3 seconds.

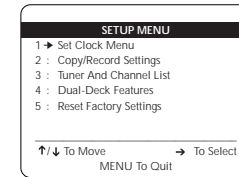
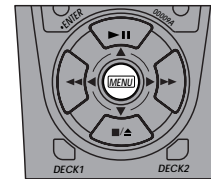

2 Select "Dual-Deck Features"

Press 4.

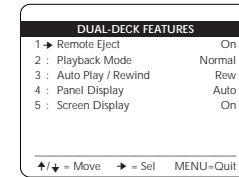
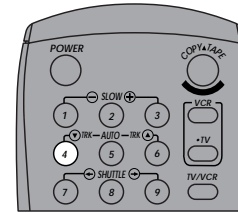

3 Set "Playback Mode"

Press 2 to select from the following options:

- **Normal** — Tapes play normally (default setting).
- **Seq** (Sequential) — When the tape in Deck 1 finishes playing, the tape in Deck 2 will begin playing automatically.
- **Loop** — When the tape in Deck 1 finishes playing, the tape in Deck 2 will begin playing automatically and Deck 1 will rewind. When the tape in Deck 2 finishes playing, the tape in Deck 1 will play again. This process will repeat continuously until you press Stop on the deck in Play.

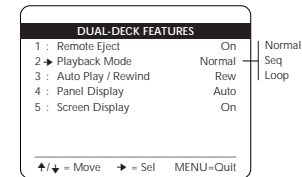
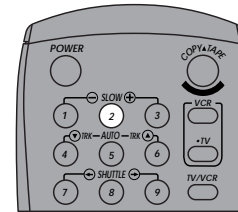

Auto Play/Rewind

If you want tapes to play automatically when you insert them, turn on Auto Play. If you want tapes to rewind automatically when they are done playing, turn on Auto Rewind.

Note: Only tapes that are missing the Record Safety Tab will play automatically when inserted.

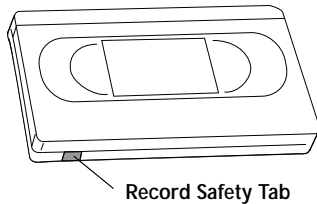

1 Open "Setup Menu"

Press and hold the menu button on the remote control for 3 seconds.

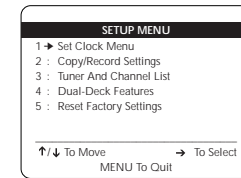
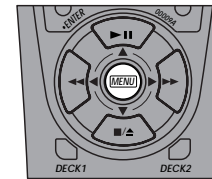

2 Select "Dual-Deck Features"

Press 4.

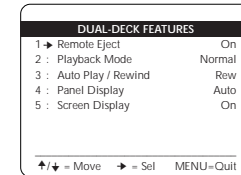
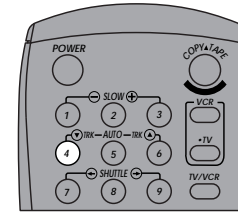

3 Set "Auto Play/Rewind"

Press 3 to select from the following options:

- **Both** — Enables both Auto Play and Auto Rewind.
- **Play** — Enables Auto Play only. Tapes without Record Safety Tabs will play automatically when you insert them.
- **Rew** — Enables Auto Rewind only. Tapes will rewind automatically when they are done playing.
- **Off** — Disables both Auto Play and Auto Rewind.

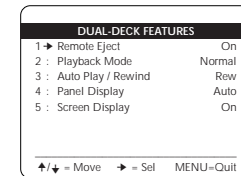
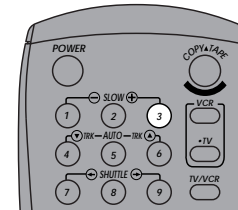

Both
Play
Rew
Off

7 - Recording Features

Basic Recording

You can record a TV show in progress by inserting a blank tape and pressing the Record button. You can even add time in fixed 30-minute increments by pressing the Record button repeatedly.

Note: Be sure your videotape has a Record Safety Tab. If the tab is missing, you can cover the opening with a small piece of tape. Warning: Do not cover this opening unless you are sure you want to record over the tape.

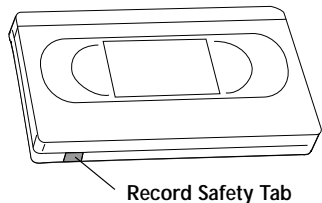

1 Insert Tape

Insert a blank VHS tape into either deck.



2 Select a Channel to Record

Use the 0-9 buttons or the Channel Up/Down arrow keys to select the desired channel.

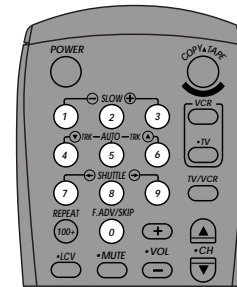

Or



3 Start Recording

Press the Record button. For options while a recording is in progress, see Recording Options on the next page.

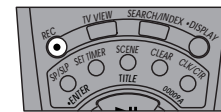

Notes:

- Be sure the TV is set to channel 3 or 4 (whichever the switch is set to on the back of the VCR).
- Make sure the TV/VCR button on the front panel is set to VCR (the VCR icon will appear on the front panel display).
- Be sure the tape is long enough to record the entire program. To change the recording speed, see page 50.

Recording Options

While a recording is in progress, you can watch a different channel, watch a videotape in the other deck, or add recording time in 30-minute increments.

To Stop Recording...

Press Stop.

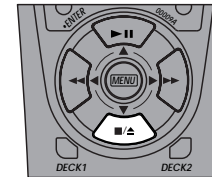

To Pause Recording...

Press Play/Still. To resume recording, press Record.

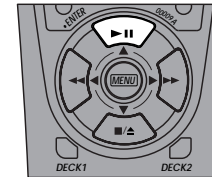

To Watch a Different Channel...

Press the TV/VCR Button on the remote or front panel to switch to TV mode (the VCR icon will disappear from the front panel display), then select a different channel using your TV's tuner.

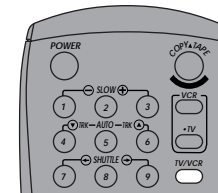

To Watch Another Videotape...

Insert a tape in the deck that is not recording and press Play. The TV View will automatically change to the playback deck.

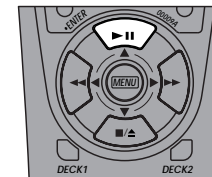

To Add Recording Time...

See One-Touch Recording (OTR) on page 49.

One-Touch Recording (OTR)

One-Touch Recording (OTR) allows you to add recording time in 30-minute increments (up to 9 hours and 30 minutes) at the touch of a button.

1 Start Recording

Follow the instructions on page 47.

2 Activate OTR

While in Record mode, press Record again to activate One-Touch Recording. OTR 0:30 will appear on the On-Screen Display and the VCR will record for exactly 30 minutes.

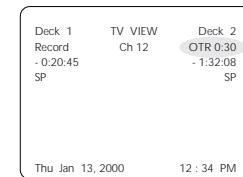
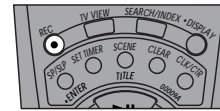

3 Add Recording Time

Continue pressing Record to add recording time in 30 minute increments up to 9 hours and 30 minutes.

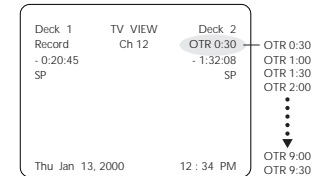
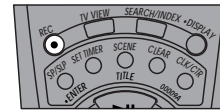

4 Activate Loop Record

When you reach OTR 9:30, press Record again to enter Loop Record. The active Deck will record over and over again in a continuous loop until you press Stop. This can be used for continuous recording of security cameras.

Notes:

- If you press Power during an OTR session, the Dual-Deck VCR will turn off automatically when the recording time has elapsed.
- When the recording time has elapsed, the VCR will stop recording automatically.

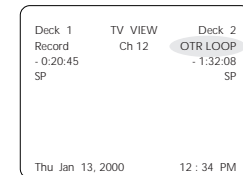
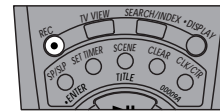

Record Speed

You can adjust the Record Speed to fit more than 2 hours of programming on a T-120 tape.

1 Start Recording

Follow the basic Recording instructions on page 47.

2 Set Record Speed

Press the SP/SLP button on the remote control to switch the record speed between:

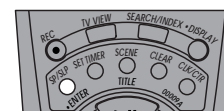

- **SP** — Standard Play, for best quality.
 - **SLP** — Super Long Play, for maximum recording time (3 times SP).
-

Maximum Recording Time - SP vs. SLP

Tape Length	SP (Standard Play)	SLP (Super Long Play)
T-120	2 hrs	6 hrs
T-160	2 hrs 40 mins	8 hrs
T-180	3 hrs	9 hrs

Record Source

You can set the Dual-Deck VCR to record from the Tuner (television), Deck 1, Deck 2, Aux (front) inputs. The Auto setting will record whatever is currently visible on-screen.

1 Open "Setup Menu"

Press and hold the Menu button for 3 seconds.

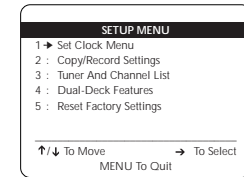
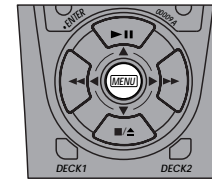

2 Select "Copy/Record Settings"

Press 2.

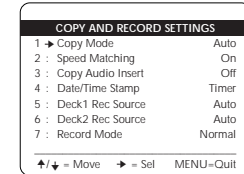
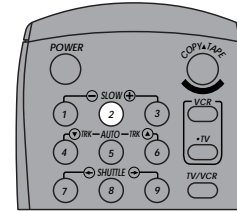

3 Set "Deck 1 Rec Source"

Press 5 to record from one of the following:

- **Auto** — The current TV View (whatever you currently see on-screen).
- **Aux** — Source connected to front line input.
- **Deck2** — Tape playing in Deck 2.
- **Tuner** — Current television program.

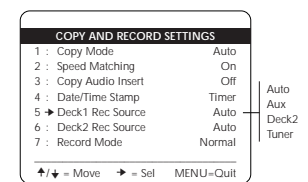
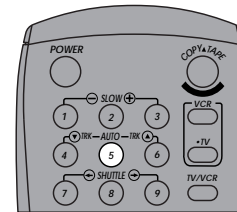

4 Set "Deck 2 Record Source"

Press 5 to record from one of the following:

- **Auto** — The current TV View (whatever you currently see on the screen).
- **Aux** — Source connected to front line input.
- **Deck1** — Tape playing in Deck 1.
- **Tuner** — Current television program.

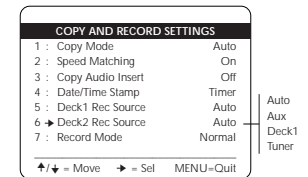
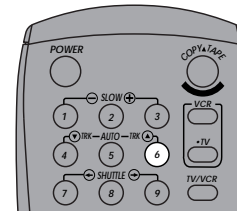

Sequential/Loop Recording

You can insert two tapes in your Dual-Deck VCR and have them record sequentially or in a continuous loop. This will allow you to record up to 18 hours of programming in SLP mode. Loop recording is useful for continuous recording of security cameras.

1 Open "Setup Menu"

Press and hold the Menu button for 3 seconds.

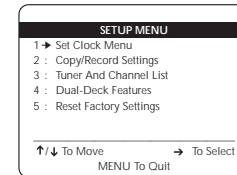
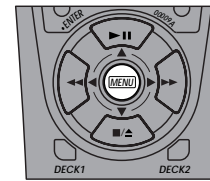

2 Select "Copy/Record Settings"

Press 2.

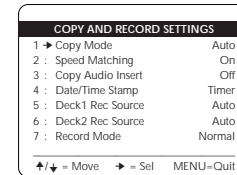
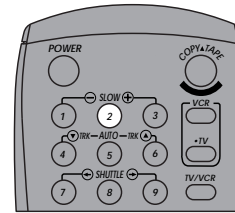

3 Set "Record Mode"

Press 7 to select from the following options:

- **Normal** — Tapes record normally (default setting).
- **Sequential** — When the tape in Deck 1 finishes recording, the tape in Deck 2 will begin recording automatically.
- **Loop** — When the tape in Deck 1 finishes recording, the tape in Deck 2 will begin recording automatically and Deck 1 will rewind. When the tape in Deck 2 finishes recording, the tape in Deck 1 will record again. This process will repeat continuously until you press Stop on the recording deck.

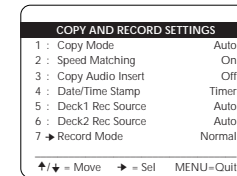
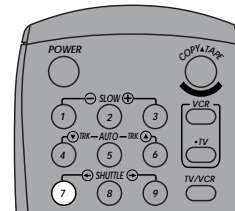

Date/Time Stamp

The Date/Time Stamp allows you to overlay the date, time, and record source at the start of, or continuously throughout, your recordings. You can use the stamp on all recordings or on timer recordings only. The stamp will not appear, however, when you copy a tape.

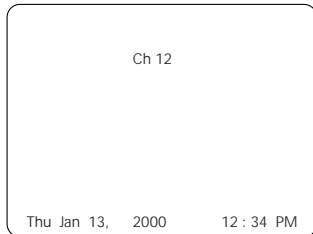

Sample Date/Time Stamp

1 Open "Setup Menu"

Press and hold the Menu button for 3 seconds.

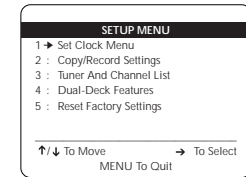
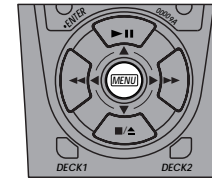

2 Select "Copy/Record Settings"

Press 2.

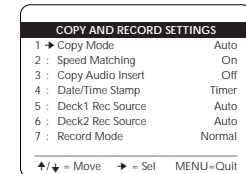
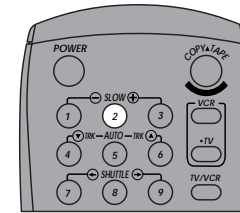

3 Set "Date/Time Stamp"

Press 4 repeatedly to set Date/Time Stamp to:

- **Timer** — The date, time, and record source will appear briefly at the start of all timer recordings only (default setting).
- **Cont (Continuous)** — The date, time, and record source will appear continuously over all recordings. The On-Screen Display and Menu system will be disabled if this setting is on. Press Stop on the recording deck to restore normal on-screen functions.
- **All** — The date, time, and record source will appear briefly at the start of all recordings except copies.
- **Off** — The Date/Time Stamp is disabled.

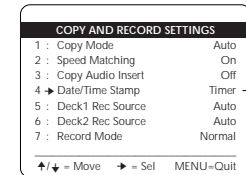
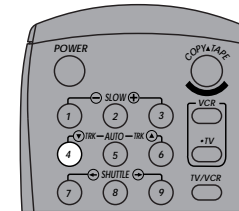

8 - Timer Recording

How to Set a Timer Recording

Sometimes you may wish to tape a show when you're not home, or you may want to create a library of your favorite programs. The Timer Recording Feature allows you to program up to 16 events at a time to record up to a year in advance.

1 Open Timer Record Menu

Press Set Timer on the remote control. Note: If you haven't set the clock, the Set Clock menu will appear. You must set it before you can program a Timer Recording; see page 7.

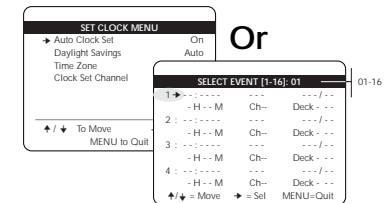
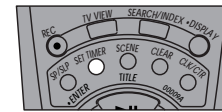

2 Choose Event Number

Use the number keys to enter an available event number between 01 and 16; e.g., for "1", press "0-1".

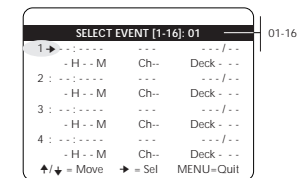
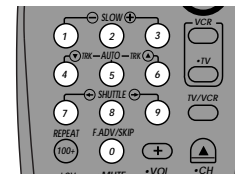

3 Set Event Date & Time

Use the number keys to set the date and time of the event. The default setting is the current date and time. To leave an entry unchanged, press the right arrow key. If you enter an invalid number, you will be prompted to reenter a valid one.

- **Set Month** — Enter the month as a 2-digit number; i.e. for January, press "01".
- **Set Day** — Enter the day as a 2-digit number; i.e. for the ninth, press "09".
- **Set Hour** — Enter the hour as a 2-digit number; i.e. for 12:00, press "12".
- **Set Minute** — Enter the minute as a 2-digit number; i.e. for 00:25, press "25".
- **Set AM/PM** — Enter 1 for AM or 2 for PM.

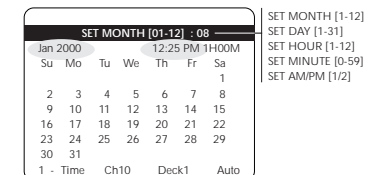
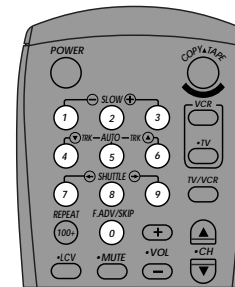

4 Set Event Length

Use the number keys to set the Length of the event. The default setting is 0 Hours and 30 Minutes.

- **Set Length (H)** — Enter the hours as a 2-digit number; i.e. for 1 hour, press "01".
- **Set Length (M)** — Enter the minutes as a 2-digit number; i.e. for 30 minutes, press "30".

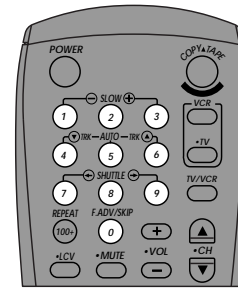

SET LENGTH (H) [0-9] : 00						
Jan 2000				12:25 PM	1:00PM	
Su	Mo	Tu	We	Th	Fr	Sa
						1
2	3	4	5	6	7	8
9	10	11	12	13	14	15
16	17	18	19	20	21	22
23	24	25	26	27	28	29
30	31					
1 - Time	Ch10	Deck1	Auto			

SET LENGTH (H) [0-9]
SET LENGTH (M) [00-59]

5 Set Event Type

Use the number keys (1-4) to set how often the event will be recorded. The default setting is "1-Time."

- 1-Time** — The event will be recorded once only.
- Monday-Friday** — The event will be recorded every weekday.
- Weekly** — The event will be recorded once a week.
- Always** — The event will be recorded every single day.

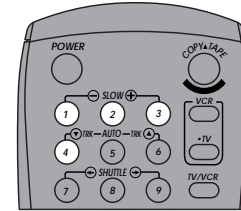

SET TYPE [1-4] : 1						
Jan 2000				12:25 PM	1:00PM	
Su	Mo	Tu	We	Th	Fr	Sa
						1
2	3	4	5	6	7	8
9	10	11	12	13	14	15
16	17	18	19	20	21	22
23	24	25	26	27	28	29
30	31					
1 - Time	Ch10	Deck1	Auto			

SET TYPE [1-4]
1 - Time
Mo-Fr
Weekly
Always

6 Set Recording Source

Use the number keys (1-2) to set the Record Source. The default setting is the current tuner (television) channel.

- 1 **Ch##** — Records from the Tuner. Use the number keys (0-9) or up/down arrow keys to set the channel number.
- 2 **Aux** — Records from the front line input.

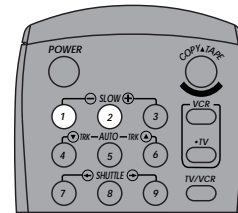

SET SOURCE [1-2] : 01						
Jan 2000	12:25 PM 1H00M					
Su	Mo	Tu	We	Th	Fr	Sa
						1
2	3	4	5	6	7	8
9	10	11	12	13	14	15
16	17	18	19	20	21	22
23	24	25	26	27	28	29
30	31					
1 - Time	Ch10	Deck1	Auto			

SET SOURCE [1-2]
Ch##
Aux

7 Set Recording Deck

Use the number keys (1-2) to set the Recording Deck. The default setting is the currently selected deck.

- 1 **Deck 1**— Show will be recorded on tape in Deck 1.
- 2 **Deck 2** — Show will be recorded on tape in Deck 2.

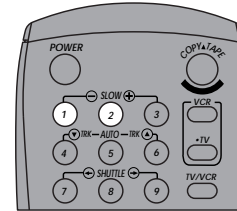

SET DECK [1-2] : 1						
Jan 2000	12:25 PM 1H00M					
Su	Mo	Tu	We	Th	Fr	Sa
						1
2	3	4	5	6	7	8
9	10	11	12	13	14	15
16	17	18	19	20	21	22
23	24	25	26	27	28	29
30	31					
1 - Time	Ch10	Deck1	Auto			

SET DECK [1-2]
Deck1
Deck2

Complete Program Record
Complete Program Record, or CPR, helps to ensure you won't run out of tape before your Timer Recording is complete. When Auto is selected, the Timer event begins to record in SP; the VCR then calculates how much time is remaining on the tape and adjusts the record speed to SLP if necessary to fit the entire event. If there is not enough tape to record the entire event, the VCR will record in SLP until the end of the tape is reached.

8 Set Recording Speed

Use the number keys (1-3) to set the Recording Speed. The default setting is Auto.

- 1 Auto** — Complete Program Record (see note at left).
- 2 SP** — Standard Play. Delivers best quality. A T-120 tape will record 2 hours.
- 3 SLP** — Super Long Play. Delivers maximum recording time. A T-120 tape will record 6 hours.

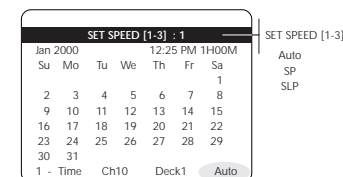
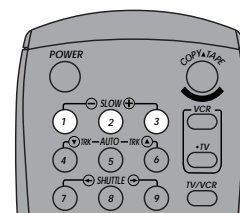

9 Confirm Settings

When all settings are complete, press Menu to confirm the Timer event and view a summary of all programmed events.

- To program another event, select another available event number.
- To edit an existing event, select an event number that has already been programmed.
- To delete an event, use the Up/Down arrow keys to select it, then press Clear.
- To exit the Event Summary screen, press Menu.

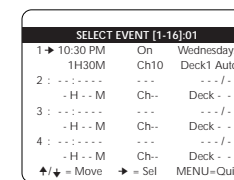
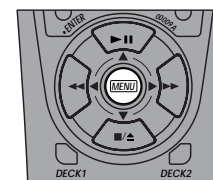

Be sure your videotape has a Record Safety Tab. If it is missing, you can cover the opening with a small piece of tape. Warning: Do not cover this opening unless you are sure you want to record over the tape.

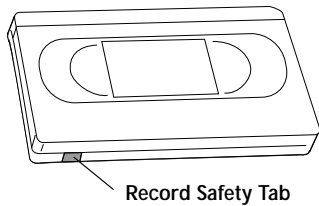

10 Insert Tape

Insert a blank tape with a Record Safety Tab into the deck you designated in Step 7.



11 Programming is Complete!

The event is stored in memory and will record at the scheduled time. A red Timer icon will appear on the front panel display to indicate that an event is programmed.

Notes:

- If there is a problem with your Timer Recording, the Timer icon will flash on the front panel display and a Timer Record Error will appear on the TV screen; see page 60.
- The event will record whether the VCR power is on or off; i.e., if the VCR power is off, it will turn on automatically when the Timer Recording begins.
- To stop an event in progress, press Stop on the recording deck. A warning message will appear on-screen. Press Stop again to cancel the event.

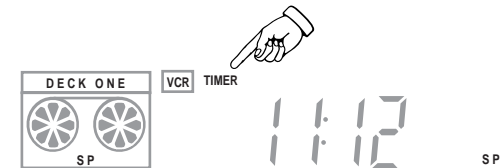

The Timer indicator appears when a Timer Recording Event has been programmed

Timer Recording Errors

If there is a problem with your Timer Recording, the word **Timer** will flash on the Front Panel Display and an error message will appear on the On-Screen Display. Once you correct the error, the event will begin if there is still time remaining for that event.

Tape Missing

There is no videotape in the recording deck.

- Insert a videotape in the recording deck.

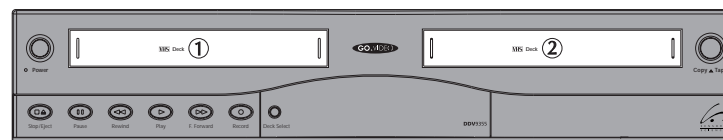

Tape Missing Tab

The videocassette is missing the Record Safety Tab.

- Insert a video cassette with the Record Safety Tab intact, or place a small piece of adhesive tape over the opening to permit recording.

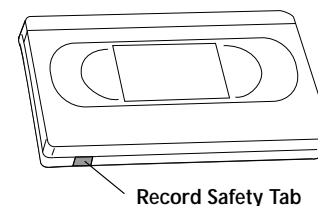

Not Ready

The recording Deck is not in Stop mode (e.g., it is playing, rewinding, etc.).

- Press Stop to stop the recording deck.

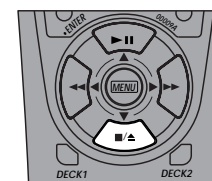

Overlapping Events

Two or more events are programmed to occur at the same time:

- When you program a new event, the VCR checks all timer events for conflicts. If two events overlap, you will be prompted to either delete one of the events, or allow them to overlap.
- If events overlap, the first event will be completely recorded, then the next event will start and the remainder of that event will be recorded.

TIMER EVENTS OVERLAP

1 2 3 4 5 6 7 8 9
10 11 12 13 14 15 16

Please review the events from the Select Event menu and remove one using the CLEAR key

SET TIMER to Continue
MENU to Quit

SELECT EVENT [1-16]:01

1	10:30 PM	On	Wednesdays
	1H30M	Ch10	Deck1 Auto
2	9:00 AM	On	Sun Dec/06
	0H30M	Line1	Deck2 SP
3	7:00 PM	On	Mon-Fri
	2H00M	Line2	Deck2 SLP
4	12:15 PM	On	Everyday
	0H15M	Ch06	Deck1 Auto

↑/↓ = Move → = Sel MENU=Quit

8-Scene Editor

There are two ways to edit movies with the Dual-Deck VCR:

1. You can use the 8-Scene Editor to automatically assemble up to 8 scenes by marking their beginning and ending points; see instructions at right.

2. You can use the Sync Edit feature, which allows you to manually cut unwanted scenes while copying a tape; see page 64.

1 Insert Source Tape

Put the tape with your unedited source material in Deck 1.



2 Insert Target Tape

Put your blank tape in Deck 2. To ensure quality edits, it is best to record on blank or pre-formatted tapes. Tip: You can pre-format your tapes by recording the line input over the entire tape with no signal.



3 Review Source Tape (optional)

Make a list of the scenes you wish to use in your final movie with their beginning and ending tape counter positions. Reorder the scenes if desired.

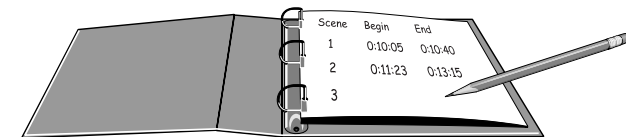

4 Open "Main Menu"

Press Menu.

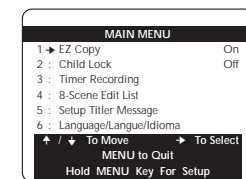
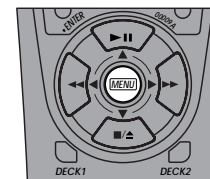

5 Select "8-Scene Edit List"

Press 4 to open the 8-Scene Edit List menu.
The number "1" and "Begin" will flash.

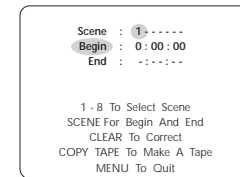
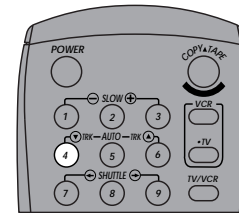

6 Select Scene Number

Use the number keys to choose a scene from 1 to 8. You can enter scenes in any order.
The scene number you choose will flash.

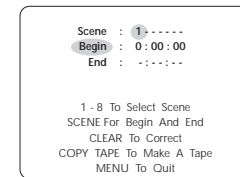
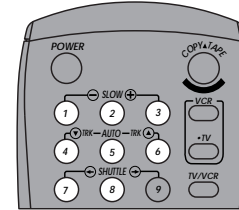

7 Mark Beginning of Scene

Play the tape to the beginning of the desired scene and press the Scene/Title button. The scene number and "End" will flash. Use the special playback functions to quickly find the position you want; see page 42.

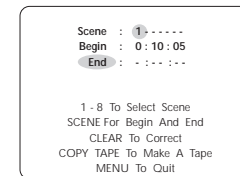
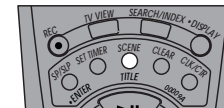

8 Mark End of Scene

Play the tape to the end of the desired scene and press the Scene/Title button. The next available scene number and "Begin" will flash.

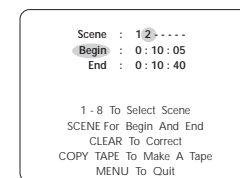
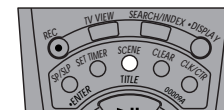

9 Clear Unwanted Scenes

If you are not satisfied with a particular scene, use the Clear button to erase its beginning and ending points. Repeat Steps 6-8 to load up to 8 scenes at a time.

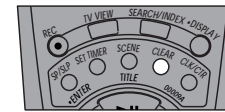

10 Make a Tape

When you are satisfied with the order and length of each scene, press Copy Tape to begin assembling the tape.

Notes:

- The Dual-Deck VCR will automatically copy each scene in order from the source tape to the target tape.
- When the process is finished, return to Step 6 to add more scenes, or press Menu to quit.

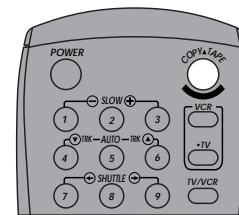

Sync Editing

Sync (as in “synchronized”) Editing is useful if you only want to copy part of a tape, or if you want to cut commercials while copying a TV show. The Copy Tape button is the key to synchronizing the playback deck with the recording deck.

1 Before You Begin —

- Turn off Auto Play; see page 45.
- Turn off EZ Copy; see page 36.

2 Insert Source Tape

Put the tape with your unedited source material in Deck 1.

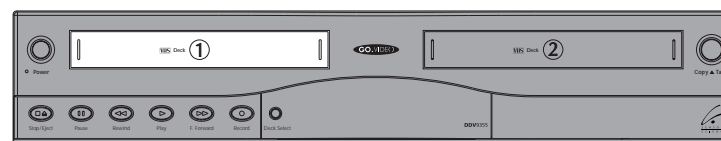

3 Insert Target Tape

Put your blank tape in Deck 2.



4 Position Target Tape

Play the tape in Deck 2 to the place where you wish to begin copying, then press Still. Tip: Leave at least 1 minute of blank tape at the beginning of a tape to ensure a crisp edit.

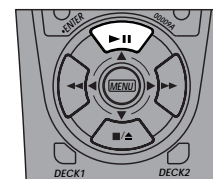

5 Set Target Tape to Record/Pause

While the target tape is in Play/Still mode, press Record for Deck 2. This puts the deck in Record/Pause mode.

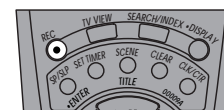

To automatically cut commercials when performing a Sync Edit, see Skip Edit on the following page.

6 Position Source Tape

Play the tape in Deck 1 to the beginning of the scene you wish to copy, then press Still. Use the special playback functions to quickly find the position you want; see page 42. Copy will flash on the front panel display.

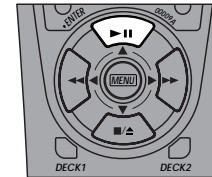

7 Start Sync Edit

Press the Copy Tape button. The tape in Deck 1 will begin copying to Deck 2.

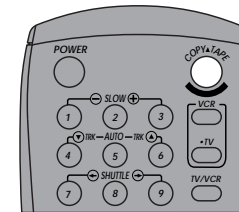

8 Pause/Resume Sync Edit

Press the Copy Tape button to pause the Sync Edit. Copy will flash on the Front Panel Display. To resume, press Copy Tape again. With the Sync Edit paused, you can reposition the source tape in Deck 1, e.g. to fast-forward over a commercial.

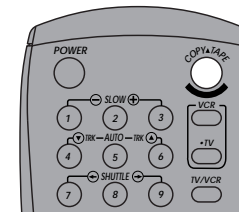

9 Stop Sync Edit

To stop the Sync Edit process, press Stop on both decks.

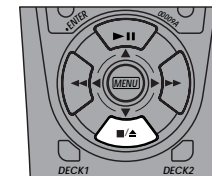

How to Cut Commercials with Skip Edit

The Skip Edit feature allows you to remove commercials during a Sync Edit at the touch of a button. Commercials typically run from 1 to 5 minutes in length. Each time you press Skip Edit, you will automatically cut 1 to 5 minutes of source tape from your target tape.

1 Set Up a Sync Edit

Follow Steps 1-6 on pages 64-65.

2 Preview Commercials

As you position your source tape, note how many minutes the commercials are that you wish to cut.

3 Start Sync Edit

Press Copy Tape to begin copying the source tape from Deck 1 to Deck 2.

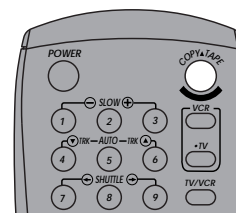

4 Cut the Commercials

When the commercials start, press F.Adv/Skip once for every minute of commercials to be deleted. The Dual-Deck VCR will automatically skip edit (omit) the commercials on the target tape, then resume copying.

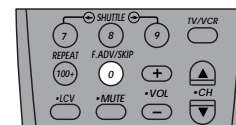

On-Screen Titler

You can add titles or credits to your movies with the On-Screen Titler. Create your message from over 100 letters, numbers and symbols. There are two steps to using the titler: Setting up the Titler Message and Recording the Title; see page 68.

1 Open "Main Menu"

Press Menu on the remote control.

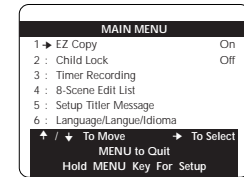
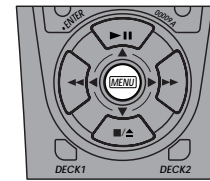

2 Select "Setup Titler Message"

Press 5.

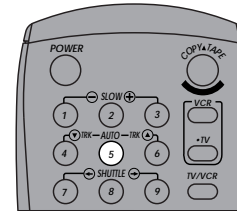

3 Compose Your Message

Use the up, down, left, & right arrow keys to select each character in your message, pressing Title after each to insert the character at the current cursor position.

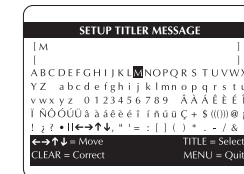
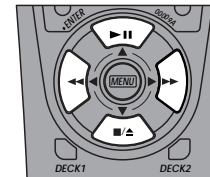

4 Edit Your Message

If you make a mistake, press Clear to back-space and delete the previous character.

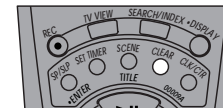

5 Save Your Message

When you are satisfied with your message, press Menu to save and quit. To record your Titler message, see page 68.

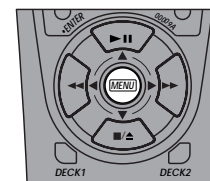

Overview

The Dual-Deck VCR Search/Index features allow you to scan and search for Index Marks, quickly find blank space on a tape, search for exact tape counter positions, and return to 0:00:00. The real-time tape counter gives you real-time feedback on the precise position of your tapes.

Clk/Ctr Button

Press the Clk/Ctr button repeatedly to cycle the front panel display through the following three views:

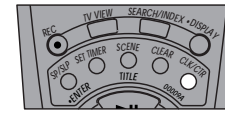

1 Clock

Shows you the current time as set in the Set Clock Menu.



2 Real-Time Tape Counter

Shows you the current tape position in the active deck in hours, minutes, and seconds.



3 Time Remaining

Shows you the amount of time left on the tape in the active deck, computed by subtracting the current tape position from the total tape length in hours and minutes.



Note: The Clock/Counter/Time Remaining display will not appear if there is a deck status message on the front panel display, such as Copy, or if there is no tape in the currently selected deck.

Placing Index Marks

Index Marks are like bookmarks on your videotapes. They are inserted automatically at the start of every recording, or you can place them manually anywhere on a tape. Later you can locate these "bookmarks" using Index Search or Index Scan.

Automatic Index Marks

Index Marks are placed automatically whenever you start recording. This includes Recording, OTR (One Touch Recording), Timer Recording, Copying, or Sync Editing.

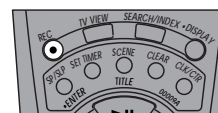

Manual Index Marks

You can place an Index Mark manually any time a tape is recording by pressing Search/Index on the remote control. "Index" will flash briefly on the On-Screen Display while the mark is recorded.

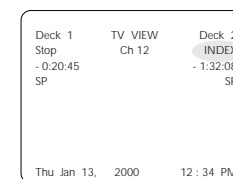
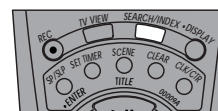

"Index" will flash briefly on the On-Screen Display while the Index Mark is being recorded.

Index Scan

Index Scan will fast-forward or rewind to the nearest Index Mark, play a few seconds of tape, and then fast-forward or rewind to the next Index Mark. When you find the show you want to watch, press Play.

Tip: Use this feature with the Date/Time Stamp to quickly find Timer Recordings on your tapes. For example, when Index Scan stops at an Index Mark and plays a few seconds of tape, you will see the date & time the show was recorded!

1 Open "Search Menu"

From Stop or Play mode, press the Search/Index button.

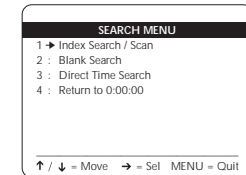
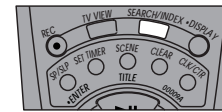

2 Select "Index Search/Scan"

Press 1.

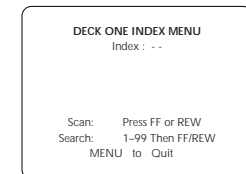
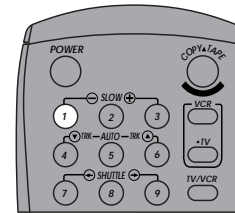

3 Scan for Index Marks

Press Fast-Forward or Rewind to begin scanning for Index Marks forwards or backwards.

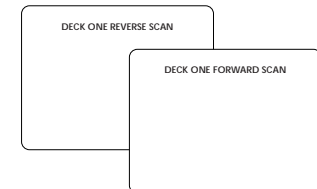
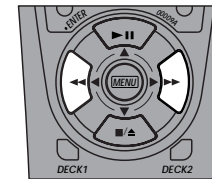

4 Review the Tape

When Index Scan locates an Index Mark, it will play the tape for 5 seconds. If it is the scene you want to watch, press Play. If it is not, the VCR will automatically search for the next Index Mark.

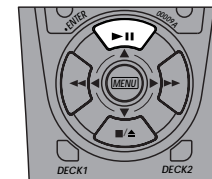

Index Search

Index Search will fast-forward or rewind a specified number of Index Marks from 1 to 99. When it reaches the desired Index Mark, it will play the tape. Use Index Search when you know the exact Index Mark you want to locate.

1 Open "Search Menu"

From Stop or Play mode, press the Search/Index button.

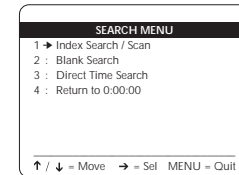
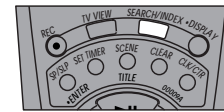

2 Select "Index Search/Scan"

Press 1.

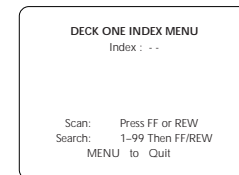
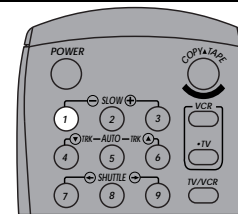

3 Enter # of Marks to Search

Enter a number from 1 to 99; e.g. for "5" press "0-5".

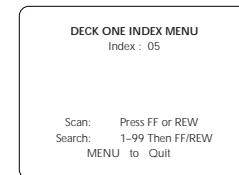
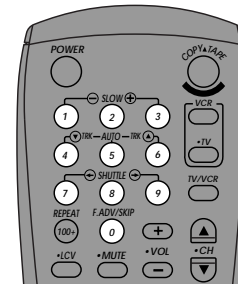

4 Search for Index Marks

Press Fast-Forward or Rewind to begin searching forward or backward for the specified Index Mark. When the VCR locates the Index Mark, it will play the tape.

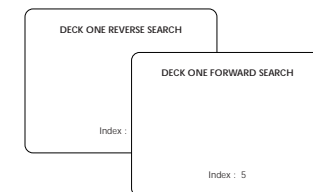
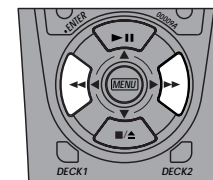

Blank Search

With Blank Search you can easily locate the next available blank (unused) segment on your videotape.

1 Open "Search Menu"

From Stop or Play mode, press the Search/Index button.

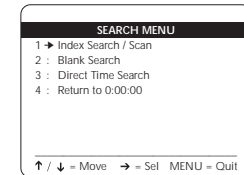
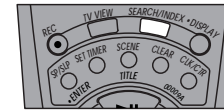

2 Select "Blank Search"

Press 2. The Dual-Deck VCR will automatically search for the next available blank space on your tape and stop. If no blank space is found, the tape will eject.

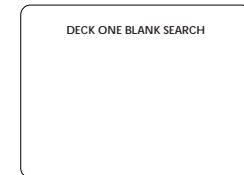
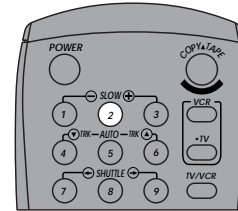

Direct Time Search

Use Direct Time Search to locate a specific tape location in hours, minutes, and seconds. This is useful for editing purposes, i.e. you can advance the tape directly to the beginning of the desired scene.

1 Open "Search Menu"

From Stop or Play mode, press the Search/Index button.

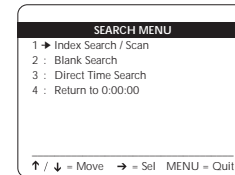
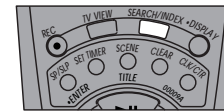

2 Select "Direct Time Search"

Press 3.

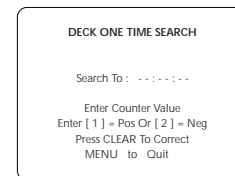
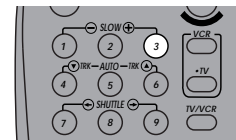

3 Select +/- Counter Value

Press 1 for positive or 2 for negative counter values.

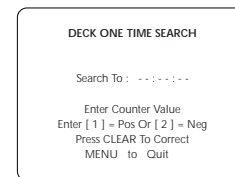
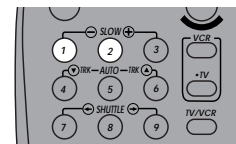

4 Enter the Time

Use the number keys (0-9) to enter the desired time in hours, minutes, and seconds. Press Clear if you need to backup and re-enter a number.

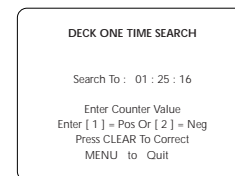
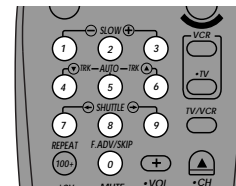

5 Start the Search

Press Search/Index to advance the tape to the specified time.

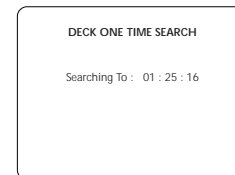

Return to 0:00:00

You can advance your video-tapes to tape counter position 0:00:00 at the touch of a button. This feature is useful when editing from a baseline counter value of 0:00:00.

1 Open "Search Menu"

From Stop or Play mode, press the Search/Index button.

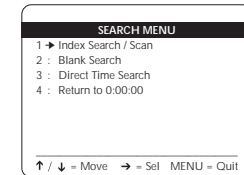
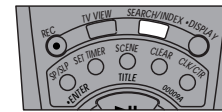

2 Select "Return to 0:00:00"

Press 4. The tape will rewind or fast-forward to tape counter position 0:00:00.

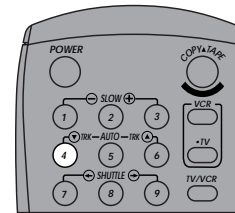

Cable Box Hookup

This chapter will show you how to connect an external device, such as a cable box, stereo, or satellite receiver, to your Dual-Deck VCR.

1 Connect Cable to Cable Box

Connect an RF antenna cable from your cable wall outlet to the "In from Cable" jack on the Cable Box.

From Cable Wall Outlet

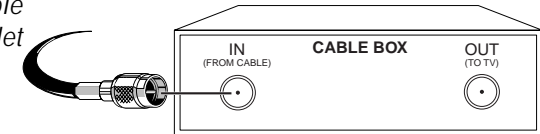

2 Connect Cable Box to VCR

Connect a second RF cable from the "Out to TV" jack on the Cable Box to the "IN (FROM ANT.)" jack on the back panel of the VCR.

From Cable Box

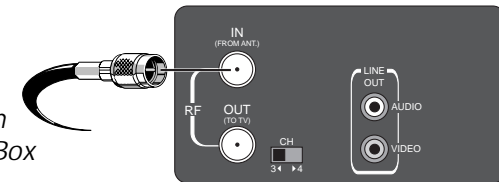

3 Connect VCR to TV

Connect the supplied RF cable from the "OUT (TO TV)" jack on the back panel of the VCR to your television's "Antenna In" jack.

To TV

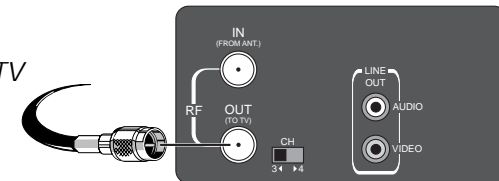

4 Plug In VCR

Connect the VCR power cord to a standard 120V/60Hz wall outlet.

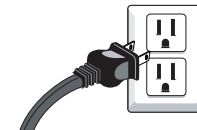

5 Turn On TV, VCR & Cable Box

Press the power buttons on the remote control, TV, and Cable Box.

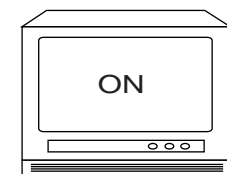
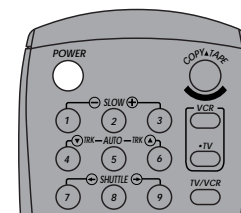

6 Set VCR Output Channel

Set the channel switch on the back panel of the VCR to 3 or 4, whichever is NOT used by your cable box.

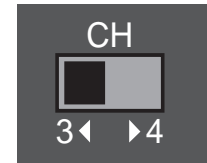

7 Tune TV to the Same Channel

Select the channel you used in step 6.

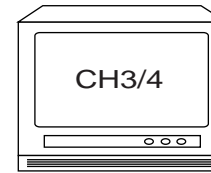

8 Connection is Complete!

The Set Language menu will appear on your television screen. Please proceed with Auto Setup on page 5.

Notes:

- Use your cable box to select channels.
- If you are not getting a good picture, repeat steps 6 and 7 using the other channel; i.e. channel 4 instead of channel 3.



Audio Connections

You can enjoy improved sound when watching movies and TV shows by connecting your Dual-Deck VCR to your home audio receiver or TV.

1 Connect VCR to Audio Receiver

Connect an RCA cable from the Audio Output on the back of the VCR to one of the Auxiliary Inputs on your audio receiver or TV. If your television has a video input, you can also connect it to the VCR's Video Output with an RCA cable.

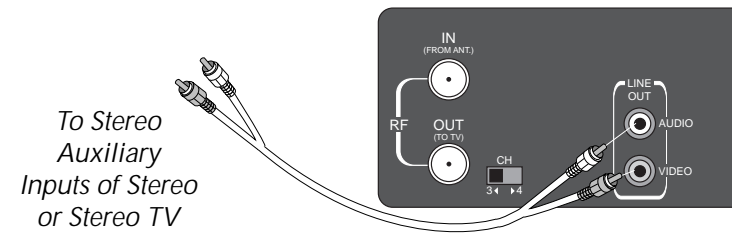

2 Set Audio Receiver to Aux

Set your audio receiver or television to "Aux" or "Tape," whichever selects the line input for your particular device.

3 Play a Tape

Insert a videotape in your VCR and adjust the volume on your audio receiver or television. You should hear the audio through your speakers.



TV Monitor Connections

Monitor-style televisions offer improved sound and picture over regular televisions because they receive the audio and video signals directly from the VCR through the auxiliary inputs.

Note: A TV monitor is not the same as a computer monitor.

1 Connect VCR to TV Monitor

Connect RCA cables from the Audio and Video Outputs on the back of the VCR to the Audio and Video Inputs on your TV monitor.

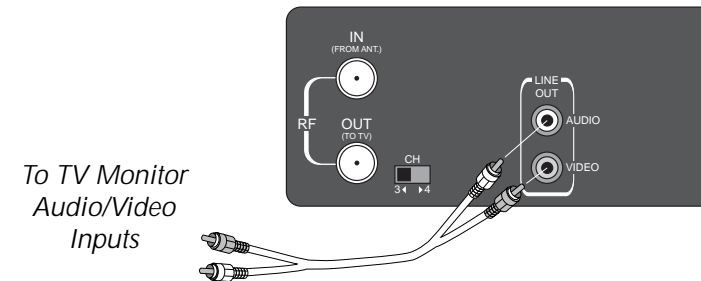

2 Set TV to Auxiliary Mode

Set your TV monitor to "Aux," "Video," or "Line." Refer to your monitor's owner's manual for the correct setting.

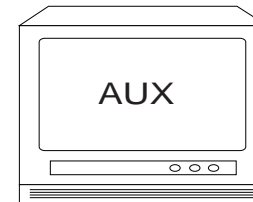

3 Connection is Complete!

Note: With this connection, the TV/VCR button has no effect. It is as if the TV/VCR button were always set to VCR.

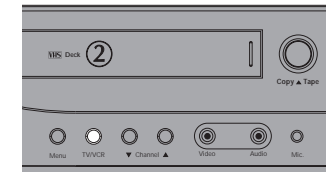
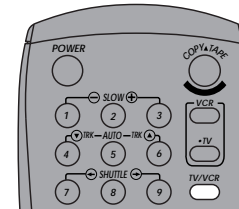

Connecting Other Video Equipment

You can connect a wide variety of audio/video equipment to your Dual-Deck VCR, including:

- A Third VCR
- Laser Disc Player
- DVD Player
- Camcorder
- Satellite Receiver
- Video Game

Since all of these devices use essentially the same connections, they will be described together.

1 Connect Device to VCR

Connect RCA cables from the Audio and Video Outputs of your external device to the Audio and Video Inputs on the front or back of the VCR.

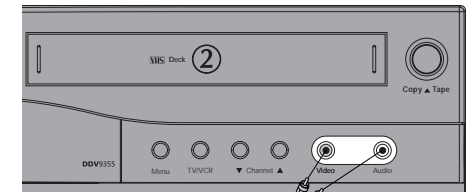

To Audio/Video Outputs of External Device

2 Watch Device

Press the TV View button until the playback from the Aux input appears on your TV screen.

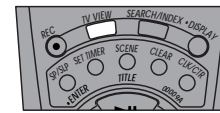

3 Record From Device

Press the TV View button until the playback from the Aux input appears on your TV screen, then press Record on the active deck.

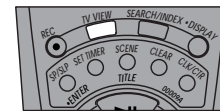

4 Timer Record From Device

Select Aux as your record source in the Timer Record menu. All other Timer Record settings should be set in the usual manner; see page 55.



Multi-Brand Remote Setup

You can program your remote control to operate many popular brands of televisions. Find your TV on the list at right and follow the instructions for setup. To determine which remote control buttons are available to control your TV, see the table on the following page.

1 Turn On TV

Press the power button on your TV.

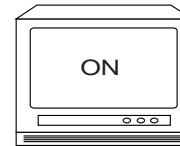

2 Program Code

Press and hold down the TV button while entering the 2-digit code for your brand of television with the 0–9 keys (see table). Note: If there is more than one code for your brand of TV, try them all until one works.

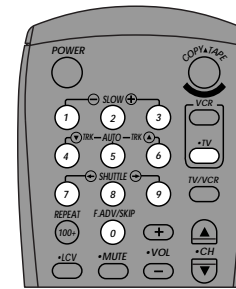

3 Check Your Results

If the TV advances to the next active channel, programming is complete! If the TV does not respond, try another 2-digit code. Some TV's are not listed but can be programmed.

4 Operate Your TV

Press TV to set the remote control to operate your TV. Note: When the remote control is in TV mode, it will NOT operate your VCR. To return to VCR mode, press VCR on the remote control.

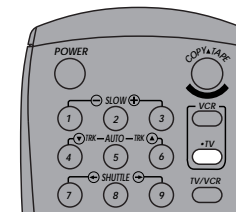

TV CODES

Daewoo	TV + 19
Emerson	TV + 21
Hitachi	TV + 10
JVC	TV + 11
LG	TV + 08
	TV + 18
LG (Goldstar)	TV + 06
Loewe	TV + 28
Magnavox	TV + 04
Mitsubishi	TV + 13
Newsan (S. America)	TV + 27
Noblex (S. America)	TV + 25
Panasonic	TV + 12
	TV + 24
RCA	TV + 07
	TV + 29
Samsung	TV + 01
	TV + 14
	TV + 15
	TV + 23
Sanyo	TV + 05
	TV + 20
Sharp	TV + 02
	TV + 16
	TV + 22
Sony	TV + 03
Telefunken (S. America)	TV + 26
Toshiba	TV + 09
Zenith	TV + 17

Multi-Brand Remote Operation

This table shows which remote control buttons are available for various brands of television.

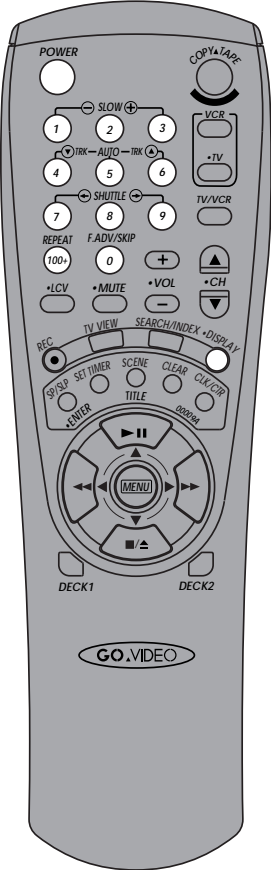

Multi-brand Remote Control

	Power	0-9	100+	Ch+/-	Vol+/-	Display
Daewoo	•	•	•	•	•	•
Emerson	•	•	•	•	•	•
Goldstar	•	•	•	•	•	•
Hitachi	•	•		•	•	
JVC	•	•		•	•	•
Magnavox	•	•		•	•	
Mitsubishi	•	•		•	•	•
Panasonic	•	•		•	•	•
RCA/GE	Off	•		•	•	•
Samsung	•	•		•	•	
Sanyo	•	•	•	•	•	•
Sharp	•	•	•	•	•	•
Sony	•	•		•	•	•
Toshiba	•	•	•	•	•	
Zenith	•	•	•	•	•	

Frequently Asked Questions (FAQs)

The following are some of the most frequently asked questions about our Dual-Deck VCRs.

If you don't find the answers you need here, you can contact our Customer Service Department as follows:

- **Phone:** (480) 922-0896
- **Office hours:**
Monday-Friday, 6:00 a.m. to 9:00 p.m. MST
Saturday-Sunday, 8:00 a.m. to 4:00 p.m. MST
- **E-Mail:** "customerservice@sensoryscience.com"
- **Web:** "www.govideo.com" or "www.sensoryscience.com". Our website includes downloadable manuals and spec sheets as well as a listing of authorized Go-Video service centers.

Why am I not getting a picture?

- Make sure the TV/VCR button on the front panel is set to VCR (the VCR icon on the front panel display should be on).
 - Make sure your TV is set to the same channel (3 or 4) as the switch on the back of your VCR.
-

Why is the picture quality poor?

- Change the channel switch on the back of the VCR, i.e. if it's set to 3 change it to 4. Then make sure your TV is set to the same channel.
 - If the picture is bad while playing a tape, try adjusting the tracking control. Press the "Auto" button (Automatic Tracking) or the TRK up/down arrows (Manual Tracking) on the remote while the tape is playing.
 - The video heads may be dirty; try cleaning the heads with a nonabrasive head cleaning tape.
-

Why can't I record from my cable box?

- Make sure the VCR is tuned to the cable box output channel (2, 3, or 4). Confirm this channel with your local cable provider.
-

Why can't I Timer Record?

- Make sure the clock is set to the correct time, and the AM/PM adjustment is set correctly.
- If you have a cable box, make sure the Record Source is set to the cable box output channel (2, 3, or 4), and that the cable box is set to the channel you wish to record.

Why isn't my remote control working?

- Make sure you are pointing the remote control directly at the VCR and that there are no obstacles between the remote control and VCR. Sunlight on the VCR front panel can sometimes interfere with the remote signal.
- Make sure the batteries in your remote are fresh and installed properly.
- The "TV" button may have been pressed by accident. This makes the remote control only operate the television. Press the VCR key on the remote and try again.

Why do my tapes record at different speeds when I use Copy Tape?

Because Speed Matching is "Off" in the Copy & Record Settings menu. Turn Speed Matching "On" to guarantee that the recording speed of the copy will match the playback speed of the source tape.

Why does the tape eject when I use Copy Tape or put a tape in to record?

Make sure the Record Safety Tab has not been removed from your tape. If the tab is missing, you can place a small piece of tape over the opening.

Why does the tape sometimes play or rewind when I don't want it to?

- Turn Auto Play/Rewind off in the Dual-Deck Features menu. When this feature is turned on, the VCR will automatically play tapes whenever you load them and/or rewind tapes when they reach the end.
- Turn EZ-Copy off in the Copy and Record Settings menu. When EZ-Copy is turned on, both decks will automatically rewind before and after recording when you press Copy Tape.

Why does my on-screen display show “Error”?

This indicates a problem with the VCR tape mechanism. Turn the power off and on again to reset. If this does not clear the error, unplug the VCR from the power outlet and inspect both tape slots for foreign objects, or for jammed or crooked tapes.

Why can't I eject a tape using my remote?

- Make sure Remote Eject is turned “On” in the Dual-Deck Features menu.
- If you have programmed scenes for editing in the 8-Scene Edit List, you cannot eject the tape in Deck 1 with the remote control. This protects you from losing your scene programming. You can either clear the scenes from the Edit List or press Stop/Eject on the front panel, which erases the scenes automatically.

Why can't I reset the Deck 1 tape counter?

- If you have programmed scenes for editing in the 8-Scene Edit List, you cannot reset the Deck 1 tape counter. This protects you from losing your scene programming. You can either clear the scenes from the Edit List or press Stop/Eject on the front panel, which erases the scenes automatically.

Why doesn't my VCR work?

- A strong static electricity shock or other unforeseen circumstances may cause the control system of your Dual-Deck VCR to lock up. To reset the control system, first unplug the power cord from the wall outlet for 10 seconds and plug it in again.
- If this doesn't restore all operations to normal, unplug the VCR again for 15 minutes. You will then need to reset the clock (if the clock is still set, you haven't unplugged it long enough).
- If these steps do not correct the problem, the Dual-Deck VCR must be serviced by an authorized service center.

Why can't I bring up the 8-Scene Edit List?

- Insert a tape in Deck 1. The VCR must have a tape in Deck 1 for the 8-Scene Edit List to appear.
- 8-Scene Edit List is not available during Copy Tape.

Why aren't the tape counters moving?

If the VCR is playing a blank section of tape (only video noise, or "snow" appears on-screen), the tape counter cannot operate. The VCR requires a control track, which is only present on recorded tape, to provide counter information.

Why can't I get a Menu or an On-Screen Display?

- If the VCR is playing a blank section of tape (only video noise, or "snow" appears on-screen), the VCR cannot produce on-screen menus or displays. Stop the tape or record on it to enable the displays.
- The remote may be set to control the TV instead of the VCR. Press the VCR button on your remote to reactivate it.
- If the Date/Time Stamp is set to "Cont" (Continuous) and a recording is in progress, the on-screen menus and displays are disabled. Press Stop on the recording deck to restore normal on-screen functions.

Why do I get a blue screen?

- If a channel is too weak to deliver a clear picture, the VCR will display a blue screen in its place. To see channels with poor reception, turn on the Show Weak Channels feature in the Tuner and Channel List menu.
- Double-check your antenna connections or tuner settings.

Why is my Power button blinking?

The VCR is in Auto Power Off mode. If you press the Power button while rewinding, copying, Timer Recording, One-Touch Recording or using EZ-Copy, the VCR will automatically turn off when the function is completed. Pressing the Power button toggles Auto Power On and Off.

Why is my Copy Tape button blinking?

This indicates that the deck is in Pause mode while copying a tape. See Sync Editing on page 64.

Why won't my remote operate all my TV functions?

The remote control does not have a command for every function on your television. Some brands of television will only respond to a limited number of functions. See the table on page 84 for a list of common brands and functions.

Technical Specifications

VIDEO SYSTEM	1/2-inch VHS system, 4 rotary head helical scanning; FM azimuth luminance; chrominance: converted sub system phase shift
TELEVISION SYSTEM	NTSC-type color signal EIA standard (525 lines, 60 fields)
AUDIO TRACK	Normal: 1 track
TAPE WIDTH	12.7 mm, 1/2 inch
TAPE SPEED	SP: 33.35 mm/s; SLP: 11.12 mm/s
PLAY/RECORD TIME	T-180 tape: SP 3 hours, SLP 9 hours
FF/REW TIME	T-120 tape: <2 minutes
HEADS	
Video:	DA 4 rotary heads
Audio:	2 rotary heads; 1 stationary head (Linear)
Control:	1 stationary head
Erase:	1 full track, 1 audio track
VIDEO	
Input:	RCA Type, 75 ohms unbalanced, 1 V P-P (x2)
Output:	RCA Type, 75 ohms unbalanced, 1 V P-P
Horiz Res:	Monochrome, more than 230 lines
S/N Ratio:	Better than 43 dB
AUDIO	
Input:	AUDIO IN (RCA) -8 dbm, 47K ohms (x2)
Output:	AUDIO OUT (RCA) -8 dbm, 1.5K ohm
TV Tuner:	181 channel frequency synthesized. VHF input Ch 2 - Ch 13. UHF input Ch 14 - Ch 69. VHF & UHF one input. Cable Ch 5A, A-5 through A-1, A-I, J through W+58, W+59 through W+84. 75 ohm unbalanced F-type connector.
S/N Ratio:	Better than 43 dB
RF MODULATION	Channel 3 or 4
POWER REQUIREMENT	120V AC, 60 Hz, 26 watts maximum
CLOCK BACKUP TIME	<1 minute
ENVIRONMENT	41-104 F (5-40 C); 10%-75% humidity
DIMENSIONS	540 x 100 x 400 mm (22" x 4" x 15 3/4")
WEIGHT	6.2 Kg (13.6 lbs.)

Dual-Deck VCR Limited Warranty

90 days labor
1 year parts

Who Provides the Limited Warranty

During the warranty period, the Go-Video Warranty Administrator will honor Dual-Deck VCR service for 90 days labor, 1 year parts from the original date of consumer purchase. See below for Commercial, Industrial or Educational use coverage. Dual-Deck VCR remote controls are warranted for 90 days from the date of purchase.

Who is Protected

This warranty protects the original consumer owner of this Go-Video product.

What is Covered and How Long

This warranty covers internal operating parts and service/labor to repair or replace covered parts in this Go-Video product for 90 days labor, 1 year parts, from the date of purchase, defined as follows: (1) Original Consumer Retail Purchase; (2) First Rental Purchase Agreement; or (3) First Lease Purchase Agreement (the "Warranty Period"). Labor and replacement parts supplied during the Warranty Period are covered only for the remaining portion of the original Warranty Period. The Go-Video Warranty Administrator shall have no liability for service under this warranty if non-OEM (Original Equipment Manufacturer) replacement parts are used in the repair of your Go-Video product.

What the Owner Must Do If Service is Required

If service under this warranty is required, contact the Go-Video Warranty Administrator at (480) 922-0896 to determine the nearest authorized Go-Video service center.

Other Warranty Coverage

Commercial, Industrial or Educational use has the same warranty coverage as stated in this warranty.

What are the Exceptions

This warranty does **not** cover: (1) Normal maintenance service, such as video head cleaning. (2) Damage from misuse, abuse neglect or accident, natural disasters or Acts of God. (3) Cabinetry, decorative parts, A/C adapters, knobs or buttons. (4) The foreign country use of this product. (5) Go-Video product which has been electronically or mechanically modified in any way or incorporated into other products. (6) Installation and set-up service adjustments. (7) Owner instruction. Your Owner's Guide provides information regarding operating instructions and user controls. For additional information, contact your authorized Go-Video dealer.

Go Video is not responsible for any shipping, handling or insurance charges.

This Exclusive Limited Warranty excludes all incidental and consequential damages. Some states do not allow the exclusion of incidental and consequential damages, so the above exclusion may not apply to you.

ALL IMPLIED WARRANTIES, INCLUDING IMPLIED WARRANTIES OF MERCHANTABILITY AND FITNESS FOR A PARTICULAR PURPOSE ARE LIMITED IN DURATION TO THE DURATION OF THIS WARRANTY PERIOD. Some states do not allow limitations on how long an implied warranty lasts, so the above limitation may not apply to you.

This Exclusive Limited Warranty gives you specific legal rights and you may also have other rights which vary from state to state.

GO-VIDEO WARRANTY ADMINISTRATOR

Sensory Science Corp.

7835 East McClain Drive • Scottsdale, Arizona 85260-1732

(480) 922-0896 • customerservice@sensoryscience.com

Index

Symbols

0–9 Buttons 23, 31, 32, 47
 100+ Button 13
 8-Scene Editor 61, 62

A

Add Channel 31
 AM/PM 8, 55
 Antenna Cable (RF) 1, 2, 77
 Antenna, Indoor/Outdoor 29
 Audio
 Connections 79
 Inputs 16, 81
 Outputs 79, 81
 Source 40
 Auto Features
 Auto Channel Search 5, 30
 Auto Clock Set 5, 7, 9, 11
 Auto Copy Mode 37
 Auto Play 19, 41, 45, 64
 Auto Power Off 88
 Auto Power On 13
 Auto Setup 3, 5, 78
 Auto Tracking (ATR) 43
 Auto Tuner Detect 29
 Aux Input 16, 26, 39, 57, 79, 81

B

Batteries 1
 Blank Search 73

C

Cable TV
 Cable Box Hookup 77
 CATV 29

Cable/DSS Button 13
 Channel Up/Down Arrows 13, 15, 47
 Child Lock 19
 Clear Button 13, 14, 23, 25, 63, 74
 CLK/CTR Button 14, 17, 69
 Clock
 Clock Set Channel 11
 Display 69
 Set Manually 7
 Clock/Counter/Time Remaining Display 69
 Commercials, Cutting 66
 Complete Program Record 57, 58
 Computer Monitor 80
 Connect
 Antenna to VCR 2
 Audio Source 40
 VCR to Monitor 80
 VCR to TV 2
 Copy
 Audio Insert 39, 40
 Basic 35
 Display 27
 Front Panel Indicator 17
 Mode 37
 Copy Tape
 During Skip Edit 66
 During Sync Edit 64
 Front panel 15
 Operation 35
 Remote control 13
 To make a tape 63
 To record titles 68
 Copy/Record Settings Menu 21, 39
 Copyright 4
 Counter Position 27
 Cue 42

D

Date and Time Display 27
 Date/Time Stamp 53, 71
 Day, Set 8, 55
 Daylight Savings Time, Set 7, 9
 Deck 1
 Record Source 51
 Remote Button 14
 Tape Status 17
 Deck 2
 Record Source 51
 Remote Button 14
 Tape Status 17
 Deck Play/Record Speed 27
 Deck Select Button 15
 Deck Status 27
 Direct Time Search 74
 Display Button 14
 Display Message 27
 Double-Speed Playback 42
 Dual-Deck VCR 1

E

English 5, 6
 Error Messages 27
 Event Length, Set 56
 Event Number, Choose 55
 Event Type, Set 56
 EZ Copy 21, 36, 64

F

F.Adv/Skip Button
 Basic 13
 Frame Advance 42
 Skip 42
 Skip Edit 66

F.Forward 14, 15, 24, 42, 71, 72
Factory Settings 25
FAQs 85
Frame Advance 42
Freeze Frame 42
French 5, 6
Frequently Asked Questions 85
Front Panel Display
 Clock/Counter/Time Remaining 69
 Overview 17
 Settings 18
 Timer Record Errors 60
Front Panel Overview 15

H

Hour, Set
 Clock 8
 Timer Record 55
HQ1 (High Quality 1) 37
HQ2 (High Quality 2) 37

I

Index Marks 69, 70, 71, 72
Index Scan 71
Index Search 72
Insert Tape 41, 59
Internal Clock 5

J

Jet Search 42

L

Language
 Auto Setup 3, 5
 Cable Box Setup 78

Manual Setup 6
LCV (Last Channel Viewed) 13
Left Arrow Key 23
Length (H) 56
Length (M) 56
Loop
 Playback 44
 Recording 49
Lowest Channel Found 30

M

Main Menu 6, 21, 23, 24
Menu Button 14
Menu Navigation
 Front Panel 24
 Remote Control 23
Minute, Set
 Clock 8
 Timer Record 55
Monday-Friday 56
Month, Set
 Clock 8
 Timer Record 55
Multi-Brand Remote
 Operation 84
 Setup 83
Mute 13

N

Not Ready 60

O

On-Screen Display (OSD)
 During OTR 49

Elements 27
Index Marks 70
Overview 26
Settings 28
 Timer Record Errors 60
On-Screen Menu System 21
One-Touch Recording (OTR)
 Index Marks 70
 Overview 49
 Titler 68
Overlapping Events 60

P

Panel Display, Set 18
Pause 15
Picture Search 42
Play Button
 During Index Scan 71
 Front Panel 15
 Menu Navigation 24
Play Mode 42
Playback
 Basic 41
 Front Panel Display 17
 Special Features 42
 Speed 38
 While Recording 48
Power Button
 During OTR 49
 Front Panel 15
 Initial Setup 3
 Remote Control 13
 To Control TV 83

Q

Quick Reference Guide 1

R

RCA Cables 16, 79, 80, 81

Read Me First 1

Real-Time Tape Counter 69

Record

Basic 47

Button 14, 15

Deck 57

From Other Equipment 81

Mode 49, 68

Options 48

Safety Tab 41, 47, 59

Source 27, 51, 57

Speed 17, 27, 38, 50

Titles 67

Registration Card 1

Remote Control

Child Lock 19

Menu Navigation 23

Multibrand Setup 83

Overview 13

Remote Eject 20

Unpacking 1

Remove Channel 32

Repeat 42

Reset Factory Settings 25

Return to 0:00:00 75

Reverse Jet Search 42

Reverse Picture Search 42

Review 42

Rewind 14, 15, 17, 24, 42, 71, 72

RF Antenna Cable 77

Right Arrow Key 23

S

Satellite Receiver 77

Scene

Mark Beginning 62

Mark End 62

Number 62

Scene/Title Button 14, 62, 68

Screen Display, Set 28

Search/Index Button 14, 70, 72, 74

Search/Index Features 69

Sequential

Playback 44

Set Timer Button 55

Setup Menu 9, 21, 22

Shuttle 42

Shuttle Keys 13

Skip 42

Skip Edit 65, 66

Slow +/- Buttons 42

Slow Motion Playback 42

SLP 17, 38, 50, 52, 58

Source Tape 35, 61, 64, 65

SP 17, 37, 38, 50, 58

SP/SLP Button 14, 50

Spanish 5, 6

Special Playback Features 42

Speed Matching 38

Standard Play (SP) 50, 57, 58

Stereo 77

Still Button 14, 42, 65

Stop/Eject 14, 15, 17, 24, 73, 74

Super Long Play (SLP) 50, 58

Sync Editing 61, 64, 65, 66, 70

T

T-120 Tape 50, 58

Tape Counter 69

Tape Missing Tab 60

Tape Speed 17

Target Tape 35, 61, 64

Time Remaining 69

Time, Set 8

Time Zone 7, 9, 10

Timer

Date/Time Stamp 53

Event 58

Front Panel Display 17

Timer Recording

Date/Time Stamp 53

Error Indicator 17

Errors 60

Factory Settings 25

How to Set 55

Index Marks 70

Index Scan 71

Menu 21

OSD Messages 27

Other Sources 81

Titler 68

Titler

Composing Message 67

Recording Message 68

Tracking 13

Auto (ATR) 43

Manual 43

Tuner 26, 28, 51
Tuner & Channel List 21, 32, 33
Tuner Band 29, 30
TV Button 13, 83
TV Mode 48
TV Monitor Connections 80
TV View Button 14, 26, 27, 81
TV/VCR Button 13, 15, 17, 47, 48, 80

U

Up/Down Arrows 23, 57
User's Guide 1

V

VCR 2, 3, 17, 19
VCR Mode 17, 83
VCR Output Channel 2, 78
VHF/UHF Antenna 29
VHS, Standard 41
Video 80
Video Equipment, Connecting Other 81
Video Line Input 16
Video Line Inputs 81
Video Outputs 79, 80, 81
Voice-Overs 39
Vol +/- 13

W

Warranty 1
Watch Another Videotape 48
Weak Channels 33
Website 85
Weekly 56

X

XDS 11

Y

Year, Set 8



S E N S O R Y
S C I E N C E

7835 East McClain Drive
Scottsdale, Arizona USA 85260
www.sensoryscience.com
www.govideo.com

Printed in Korea